

tech.info

Engineering Manual for Piping Systems

Edition: August 2010



About this manual

This manual support you perform the planning and design work when the data has been compiled. It also explains our fabrication capabilities and fields of application of our premium-quality piping systems in the range of PE, PP and PVDF.

As regards this Technical Manual, please also observe the latest version of our SIMCAT CD-ROM, which includes details of all our pipes and fittings as well as valves and their technical dimensions.

For further information please contact our technical support:

+49 (0) 67 52 14-254

pipingsystems@simona.de

Content

Section	Page	
Company profile	4	
1 Material specifications and approvals	6	1
2 Internal pressure creep properties	16	2
3 Time-dependent modulus of elasticity (creep-modulus)	22	3
4 Material properties and loading capacities	28	4
5 Laying, mounting and pressure test	50	5
6 Welding	94	6
7 Classification of nominal diameters	102	7
8 Tolerances	106	8
9 Basic elements of the international system of measurement (SI)	112	9
10 Explanations	118	10
11 Services	131	11

Benefit from our passion and commitment – Welcome to SIMONA



Behind each product associated with our company stands a dedicated team that has developed and manufactured it. SIMONA draws its inspiration from the unparalleled vision, dedication and passion of its employees – and a history spanning more than 150 years.

Today, we are recognised as one of the world's leading producers of semi-finished thermoplastics.

Products tailored to your needs

SIMONA is able to offer you the most extensive range of semi-finished thermoplastics worldwide. Our comprehensive portfolio of products encompasses pipes, fittings, valves, sheets, rods, profiles, welding rods and finished parts for a diverse range of applications. The materials offered within this area span everything from PE and PP to PVDF, E-CTFE and PETG. On request, we can also develop customised products tailored to your specific requirements.

Best-in-class quality

Our products and services are designed to deliver the very best quality imaginable. When implementing your projects, we always place the greatest possible emphasis on professionalism during every stage of the process. We are supported in our efforts by a first-class Quality Management system – for total peace of mind.

Global sales network

Boasting a global network of subsidiaries and distribution partners, SIMONA is renowned as a fast, flexible and reliable partner. We look forward to assisting you.

Exceptional service

As a customer, you always take centre stage: from project development to materials procurement and on-site planning, we are committed to providing the very best consulting services. In addition, we will supply you with the full range of documentation accompanying our products and offer specialist training where required.

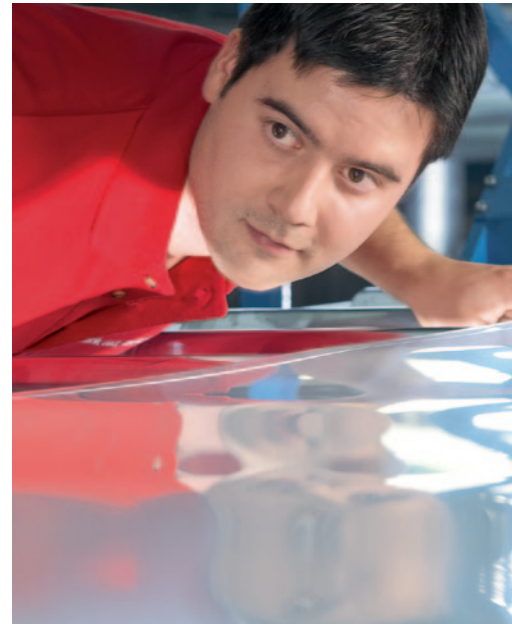

SIMONA AG's Quality and Environmental Management system is certified in accordance with DIN EN ISO 9001 : 2008 and DIN EN ISO 14001 : 2005.

The Quality Management system of SIMONA AG in compliance with the Pressure Equipment Directive is certified to 97/23/EC Annex I, para. 4.3.



1 Material specifications and approvals

1.1	Material specifications	7
1.1.1	Material specifications PE	8
1.1.2	Material specifications PP	10
1.1.3	Material specifications PVDF and E-CTFE	12

1.2	Approvals/standards	14
------------	----------------------------	-----------

1.3	Key	15
------------	------------	-----------

1.1 Material specifications



Our products are subjected to a range of thorough technical assessments as well as endurance testing. As part of this programme, our in-house laboratory conducts regular tests on material properties and long-term performance.

We are happy to pass on our knowledge, as well as performing specialist tests on your behalf.

1.1.1 Material specifications PE

Alongside its outstanding processability, polyethylene (PE) displays good chemical resistance and offers strength and rigidity within a temperature range of between -40°C and $+80^{\circ}\text{C}$. Due to the inclusion of soot particles, PE is resistant to UV light and therefore also suitable for long-term outdoor applications.

The recent development in the family of PE on the basis of PE 100 is PE 100 RC (resistant to crack) with an improved characteristic against slow crack propagation.

The electrically conductive material PE-EL dissipates static charges and prevents sparking.



Properties PE

- Excellent hydraulic properties due to smooth pipe interior
- High abrasion resistance
- Reliable protection against corrosion
- Exceptional stability and flexibility
- Outstanding light resistance and weatherability
- Good chemical resistance

Properties PE-EL

- Properties of PE, plus electrical conductivity (as per ATEX)

Material specifications	Standards/guidelines	PE 80	PE 100	PE 100 RC	PE-EL
Density, g/cm ³	ISO 1183	0.950	0.960	0.960	0.990
Yield stress, MPa	DIN EN ISO 527	22	23	23	26
Elongation at yield, %	DIN EN ISO 527	9	9	9	7
Elongation at break, %	DIN EN ISO 527	300	600	> 350	60
Tensile modulus of elasticity, MPa	DIN EN ISO 527	800	1100	900	1300
Impact strength, kJ/m ²	DIN EN ISO 179	no break	no break	26	no break
Notched impact strength, kJ/m ²	DIN EN ISO 179	12	30	30	6
Ball indentation hardness, MPa	DIN EN ISO 2039-1	40	40	40	50
Shore hardness, D	ISO 868	63	65	63	67
Mean coefficient of linear thermal expansion, K ⁻¹	DIN 53752	1.8 · 10 ⁻⁴	1.8 · 10 ⁻⁴	1.8 · 10 ⁻⁴	1.8 · 10 ⁻⁴
Thermal conductivity, W/m · K	DIN 52612	0.38	0.38	0.38	0.38
FNCT, Hours	ISO 16770/PAS 1075	> 100	> 300	> 8760	–
Surface resistance, Ohm	DIN IEC 167	1 · 10 ¹⁴	1 · 10 ¹⁴	1 · 10 ¹⁴	< 1 · 10 ⁶
Combustibility	DIN 4102	B2	B2	B2	B2
Physiological acceptability	as per BfR	yes	yes	yes	no
Chemical resistance	according to DIN 8075 Supplement	fulfilled	fulfilled	fulfilled	fulfilled
Temperature range, °C		–40 to +80	–40 to +80	–40 to +80	–20 to +60
MRS, MPa	ISO/TR 9082	8	10	10	8
OIT, min	EN 728	30	30	30	30

1.1.2 Material specifications PP

Compared to PE, polypropylene (PP) offers increased stiffness, especially in the upper temperature range (up to +100 °C). Among its key characteristics are high chemical resistance and favourable results in long-term testing when exposed to a range of media, even at high temperatures.

Owing to their low flammability PPs and PP-EL-s offer protection in the event of fire. In combination with electrical conductivity PP-EL-s is the perfect explosion prevention.



Properties PP

- Extreme toughness
- Excellent chemical resistance to many acids, alkalis and solvents
- Superior stress crack resistance
- Reliable protection against corrosion
- Low stress potential due to reduced residual stress
- Fine and stable crystalline structure
- Excellent welding properties due to fine, thermodynamically stable structure

Properties PPs

- Properties of PP, plus low flammability as per DIN 4102 B1

Material specifications	Standards/guidelines	PP-H AlphaPlus®	PPs
Density, g/cm ³	ISO 1183	0.915	0.950
Yield stress, MPa	DIN EN ISO 527	33	32
Elongation at yield, %	DIN EN ISO 527	8	8
Elongation at break, %	DIN EN ISO 527	80	100
Tensile modulus of elasticity, MPa	DIN EN ISO 527	1700	1600
Impact strength, kJ/m ²	DIN EN ISO 179	no break	no break
Notched impact strength, kJ/m ²	DIN EN ISO 179	9	6
Ball indentation hardness, MPa	DIN EN ISO 2039-1	70	70
Shore hardness, D	ISO 868	72	72
Mean coefficient of linear thermal expansion, K ⁻¹	DIN 53752	1.6 · 10 ⁻⁴	1.6 · 10 ⁻⁴
Thermal conductivity, W/m · K	DIN 52612	0.22	0.22
Dielectric strength, kV/mm	VDE 0303-21	52	22
Surface resistance, Ohm	DIN IEC 167	10 ¹⁴	10 ¹⁴
Combustibility	DIN 4102	B2	B1
Physiological acceptability	as per BfR	yes	no
Chemical resistance	according to DIN 8075 Supplement	fulfilled	fulfilled
Temperature range, °C		0 to +100	0 to +100

1.1.3 Material specifications PVDF and E-CTFE

Polyvinylidene fluoride (PVDF) belongs to the group of highly crystalline high-performance thermoplastics. PVDF retains its high level of stiffness even within the upper temperature range. The material is highly resistant to the majority of organic and inorganic media, as well as being physiologically safe and offering the benefits of low flammability.

PVDF-EL includes electrically conductive particles and displays a low level of surface resistance.



The partially fluorinated high-performance plastic ethylene-chlorotrifluoroethylene (E-CTFE) displays an extremely high degree of chemical resistance, which includes the alkaline range. In addition to its low flammability, it is physiologically safe and particularly weather-resistant.

Properties PVDF

- Excellent chemical resistance
- Physiologically safe (in accordance with BfR and FDA)
- Broad temperature range
- Low flammability (in accordance with DIN 4102 B1 and FM 4910)
- Good hydraulic properties due to smooth pipe interior
- Exceptional ageing resistance

Properties PVDF-EL

- In addition, electrically conductive

Properties E-CTFE

- Extremely high chemical resistance
- Physiologically safe (in accordance with BfR and FDA)
- Extremely broad temperature range
- Low flammability (in accordance with DIN 4102 B1)

Material specifications	Standards/guidelines	PVDF	E-CTFE
Density, g/cm ³	ISO 1183	1.780	1.680
Yield stress, MPa	DIN EN ISO 527	55	31
Elongation at yield, %	DIN EN ISO 527	8	4
Elongation at break, %	DIN EN ISO 527	30	125
Tensile modulus of elasticity, MPa	DIN EN ISO 527	1950	1650
Impact strength, kJ/m ²	DIN EN ISO 179	no break	no break
Notched impact strength, kJ/m ²	DIN EN ISO 179	12	> 100
Ball indentation hardness, MPa	DIN EN ISO 2039-1	120	56
Shore hardness, D	ISO 868	78	74
Mean coefficient of linear thermal expansion, K ⁻¹	DIN 53752	1.3 · 10 ⁻⁴	0.5 · 10 ⁻⁴
Thermal conductivity, W/m · K	DIN 52612	0.14	0.15
Dielectric strength, kV/mm	VDE 0303-21	25	-
Surface resistance, Ohm	DIN IEC 167	10 ⁺³	10 ⁺⁵
Combustibility	DIN 4102	B1	B1
Physiological acceptability	as per BfR	yes	yes
Chemical resistance	according to DIN 8075 Supplement	fulfilled	fulfilled
Temperature range, °C		-30 to +140	-40 to +150

1.2 Approvals/standards

Approvals/standards

	Dimensions, general quality requirements and tests	Standards and guidelines also applicable	Test symbols
Pipes			
PE 80/PE 100 pressure pipes	DIN 8074/8075		DIBt: Z-40.23-311 (for water-endangering liquids, §19 WHG)
PE 80/PE 100 waste-water pressure pipes	DIN 8074/8075	DIN EN 13244	
PE 80/PE 100 drinking water pipes	DIN 8074/8075	DIN EN 12201, DVGW GW 335 – Part A2	DVGW, WRAS
PE 80/PE 100 gas pipes	DIN 8074/8075	DIN EN 1555, DVGW GW 335 – Part A2	DVGW
PE 80 CoEx sewer pipes	Based on DIN 8074/8075	DIN 19537	
PE 80 effluent pipes	DIN 8074/8075	DIN EN 1519	
PE 80/PE 100 SPC protective-jacket pipes	Inner pipe based on an DIN 8074/8075	DIN 19537, DIN 19533, protective jacket as per DIN 4033 (DIN EN ISO 1610)	
PE-EL pressure pipes	DIN 8074/8075		
PP-H pressure pipes	DIN 8077/8078		DIBt: Z-40.23-325 (for water-endangering liquids, §19 WHG)
PPs ventilation pipes	Based on DIN 8077/8078	DIN 4102, fire protection classification B1	MPA: P-BWU03-I-16.5.8 (low-flammability building material)
PP-EL-s ventilation pipes	Based on DIN 8077/8078	UL 94 V-0, fire protection classification V-0	
PVDF pressure pipes	ISO 10931		DIBt: Z-40.23-323 (for water-endangering liquids, §19 WHG) FM-approval (fire protection): 3003707, class number 4910
E-CTFE pressure pipes	Based on ISO 10931		

Fittings

PE 80/PE 100 injection-moulded fittings	DIN 16963		DIBt: Z-40.23-311 (for water-endangering liquids, §19 WHG)
PE 80/PE 100 injection-moulded fittings for drinking water	DIN 16963	DIN EN 13244	DVGW, WRAS, PIIP
PE 80/PE 100 injection-moulded fittings for gas	DIN 16963	DIN EN 12201, DVGW GW 335 – Part A2	DVGW, PIIP
PE 80/PE 100 fittings for sewers and waste water pipes	DIN 16963	DIN EN 1555, DVGW GW 335 – Part A2	DVGW
PP injection-moulded fittings	DIN 16962	DIN 19537	DIBt: Z-40.23-311 (for water-endangering liquids, §19 WHG)
PVDF injection moulding	ISO 10931	DIN EN 1519	DIBt: Z-40.23-323 (for water-endangering liquids, §19 WHG) FM-approval (fire protection): 3003707, class number 4910

Regular external monitoring is performed by the following state-approved testing bodies: TÜV South Germany, SKZ, MPA Darmstadt, KIWA Netherlands, IIP Italy, Electrabel Belgium, Benor Belgium.

1.3 Key

Materials

PE	polyethylene
PE-EL	polyethylene, electrically conductive
PE RC	polyethylene, resistant to crack
PP-H	polypropylene, homopolymer
PP-R	polypropylene, random copolymer
PPs	polypropylene, flame retardant
PP-EL-s	polypropylene, electrically conductive, flame retardant
PVDF	polyvinylidene fluoride
E-CTFE	ethylene-chlorotrifluoroethylene

Norms, guidelines

ANSI	American National Standard Institute
DIBt	Deutsches Institut für Bautechnik
DIN	Deutsche Industrienorm
DVGW	Deutscher Verband für Gas und Wasser
EN	European standard
FM	Factory Mutual Research
ISO	International Standardization Organisation
TÜV	Techn. Überwachungsverein Süddt.
WRAS	Water Regulations Advisory Scheme

Abbreviations, measures and dimensions

d	outer diameter of pipe
DN	nominal diameter
e	wall thickness
kg	kilogram per piece
kg/m	kilogram per meter
m	meter
mm	millimeter
NPT	threaded female/male end conical
PN	nominal pressure
R	threaded male end cylindrical
Rp	threaded female end cylindrical
SDR	Standard Dimension Ratio (corresponds to the outer diameter of pipe divided by wall thickness)
SF	Safety factor

Materials (seals)

EPDM	ethylene-propylene-caoutchouc
FPM	fluorocaoutchouc
NBR	nitrile rubber

All measures in our delivery programme in mm. Change reserved.

2 Internal pressure creep properties

2.1	Internal pressure creep curves for PE 80 pipes	17
2.2	Internal pressure creep curves for PE 100 pipes	18
2.3	Internal pressure creep curves for PP-H pipes	19
2.4	Internal pressure creep curves for PP-R pipes	20
2.5	Internal pressure creep curves for PVDF pipes	21

2.1 Internal pressure creep curves for PE 80 pipes

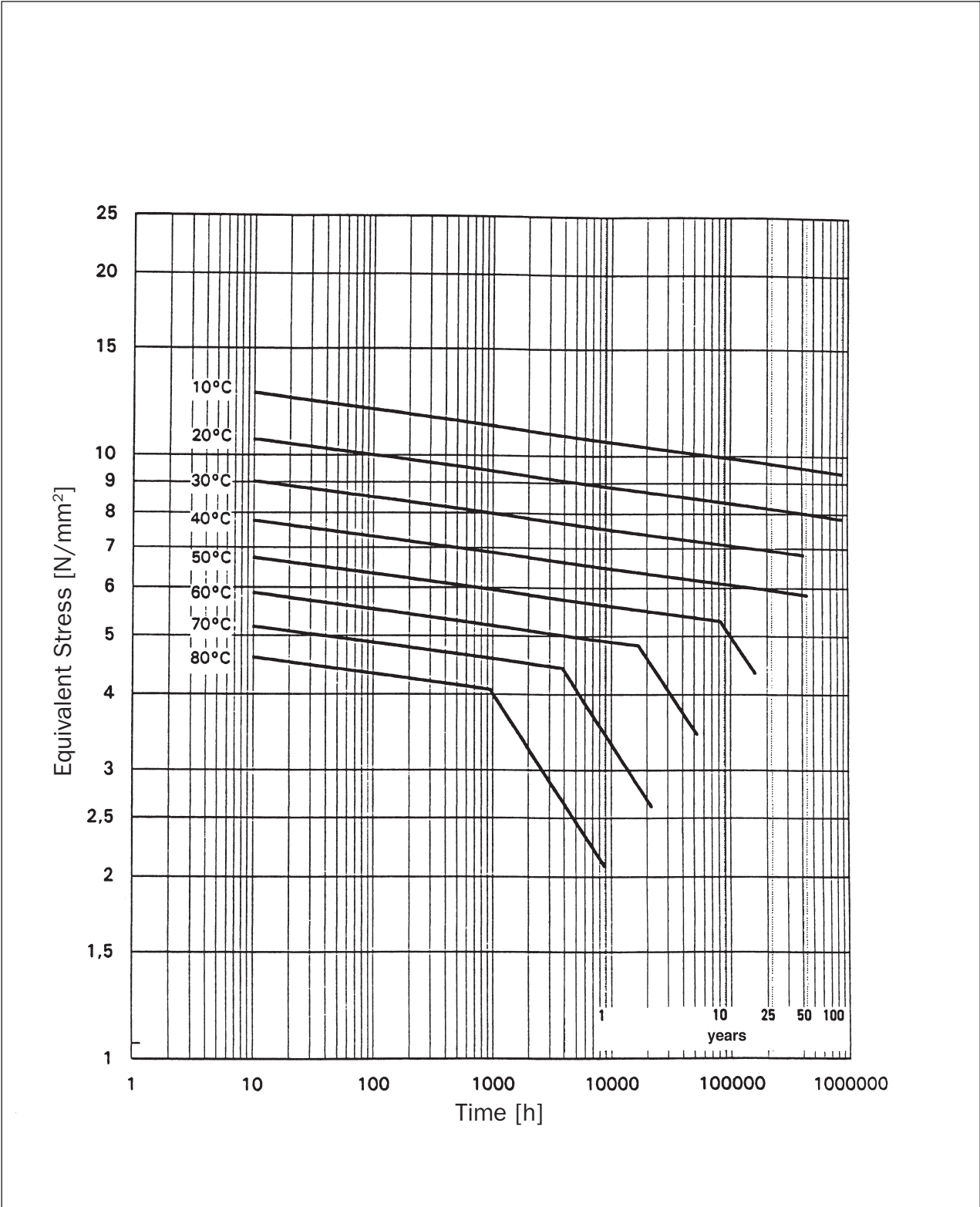

2.2 Internal pressure creep curves for PE 100 pipes

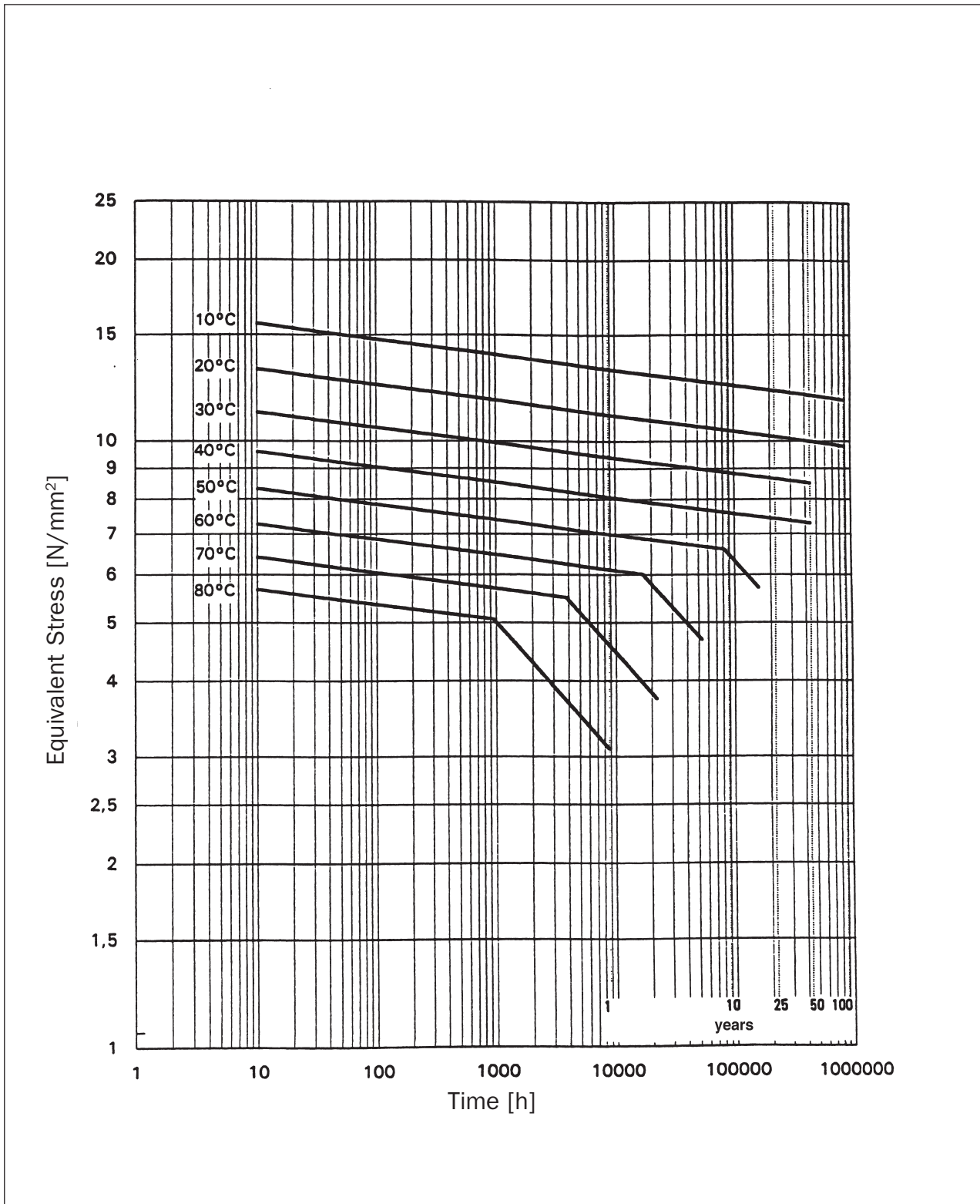

2.3 Internal pressure creep curves for PP-H pipes

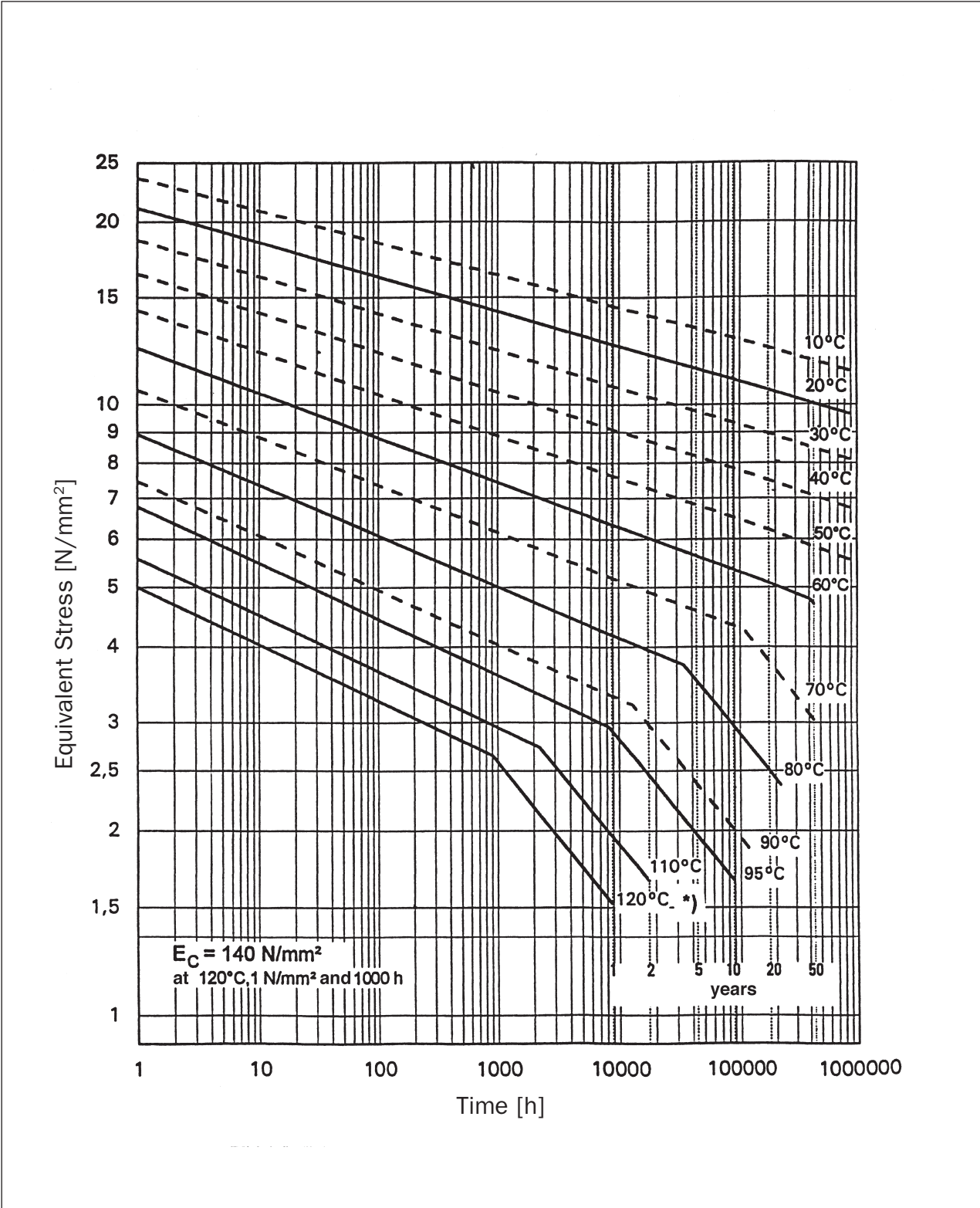

2.4 Internal pressure creep curves for PP-R pipes

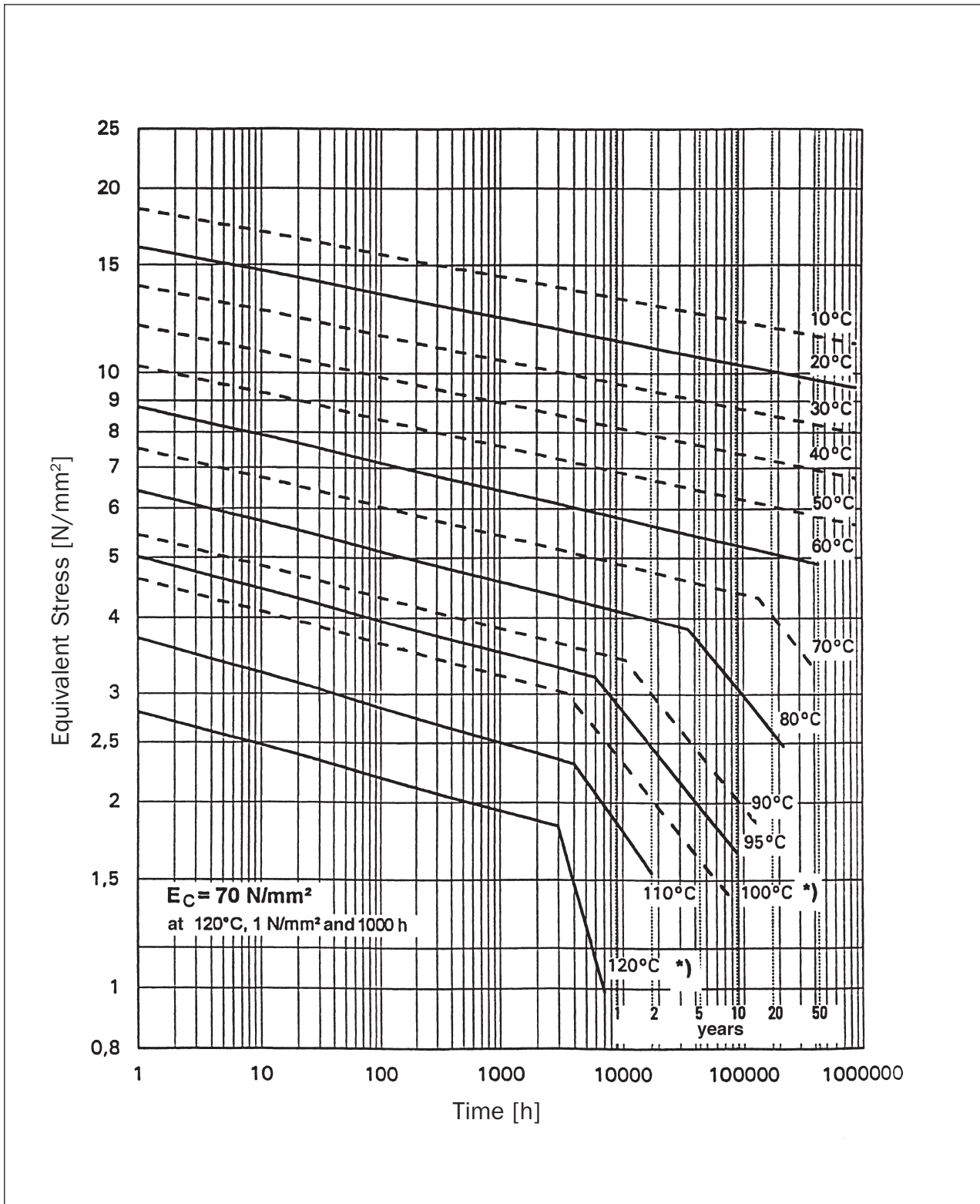

2.5 Internal pressure creep curves for PVDF pipes

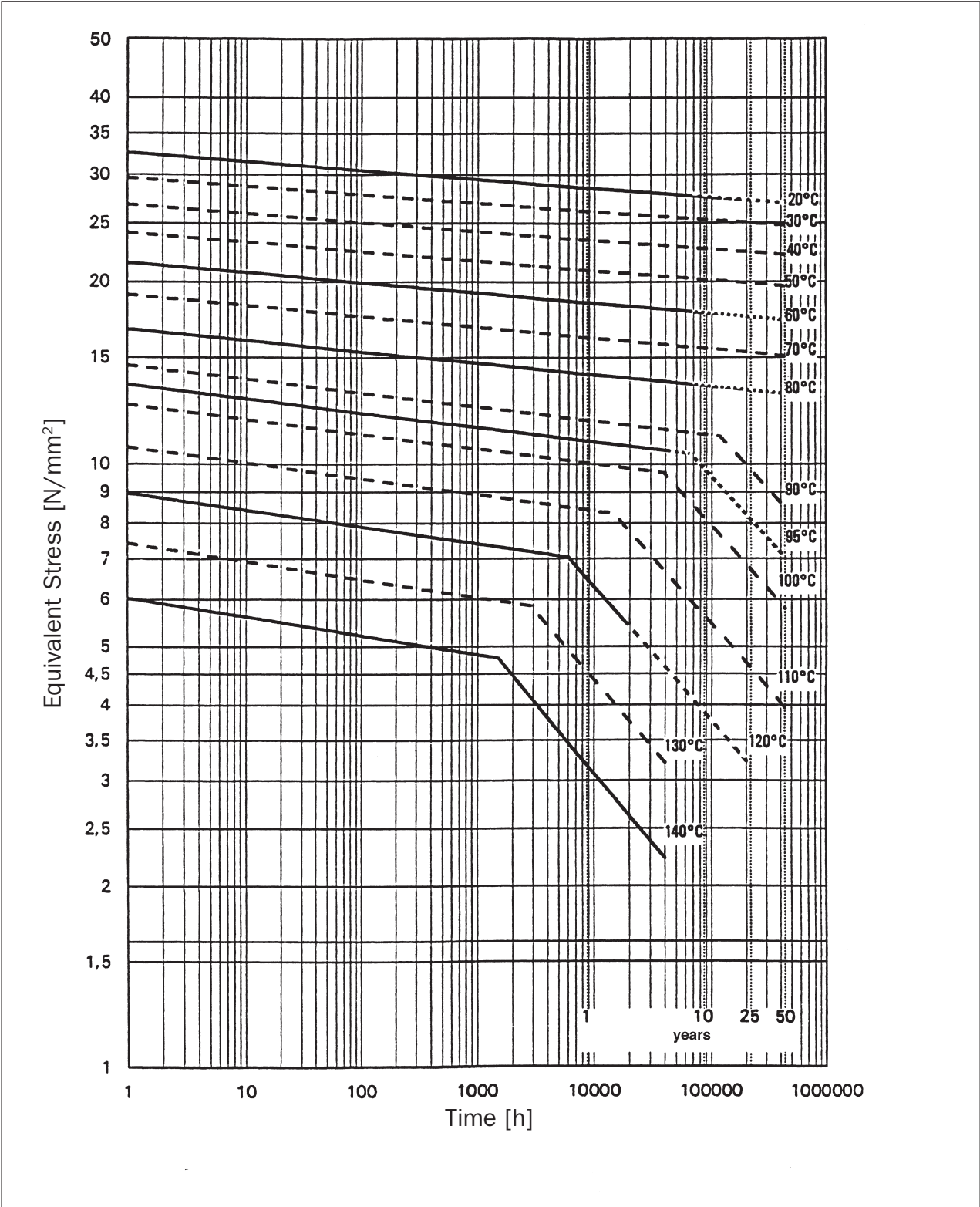

3 Time-dependent modulus of elasticity (creep-modulus)

3.1	Creep modulus for PE 80/PE 100	23
3.2	Creep modulus for PP-H	24
3.3	Creep modulus for PP-R	25
3.4	Creep modulus for PVDF	26

3.1 Creep modulus for PE 80/PE 100

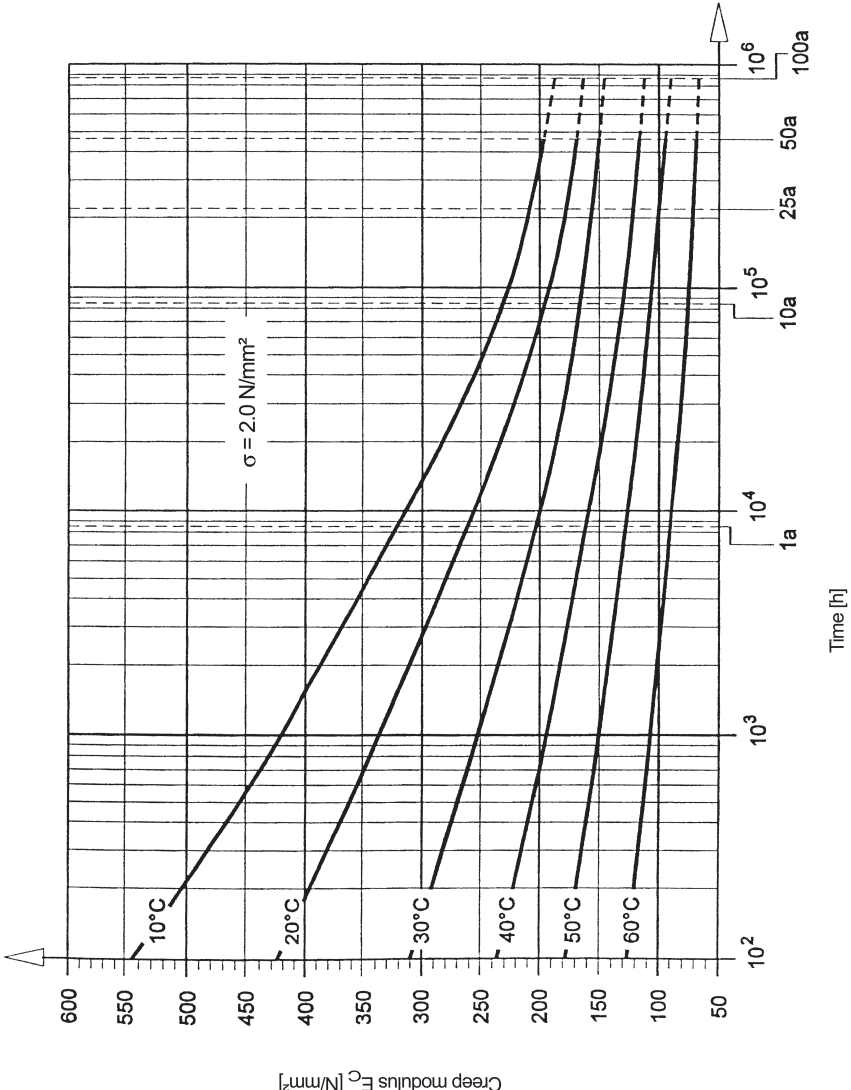

Calculation factors for the stress range

$\sigma = 0.5$ N/mm ²	1.20
$\sigma = 1.0$ N/mm ²	1.08
$\sigma = 2.0$ N/mm ²	▲ 1.00 ▼
$\sigma = 3.0$ N/mm ²	0.78
$\sigma = 4.0$ N/mm ²	0.70
$\sigma = 5.0$ N/mm ²	0.60

Modulus of elasticity [N/mm²]

Temperature	E_{kz} 10 ⁻¹ h	E_c 100min
≤ 10°C	1100	850
20°C	800	630
30°C	550	450
40°C	390	325
50°C	270	230
60°C	190	160

Note:
 Values up to 80°C in Column 1 are from DVS 2205-2 Tab. 6. Numbers in Column 2 are interpolated between E_{ST} (10⁻¹ h) and E_{LT} (1 year) according to DVS 2205-1.

3.2 Creep modulus for PP-H

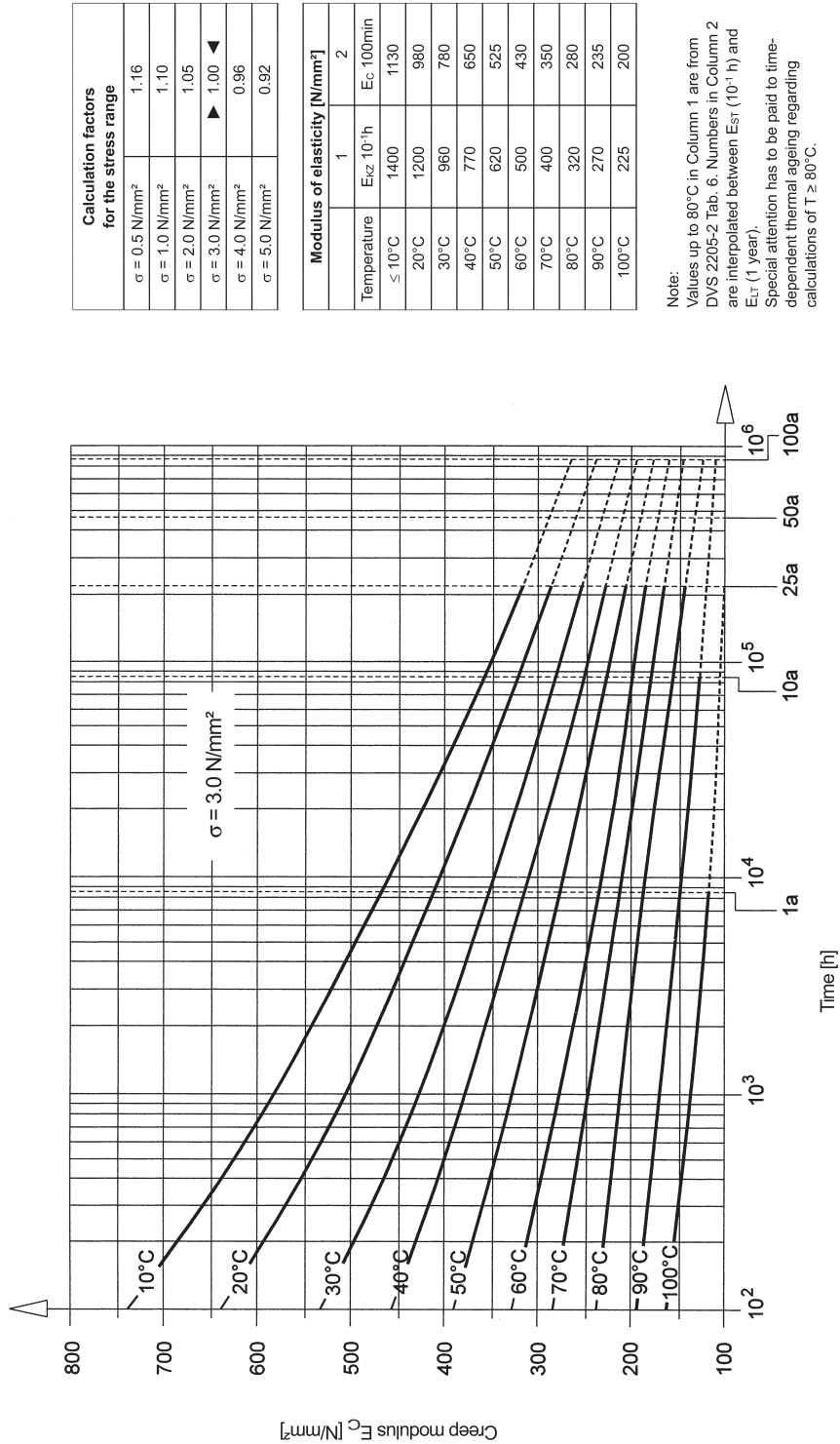

Calculation factors for the stress range	
$\sigma = 0.5$ N/mm ²	1.16
$\sigma = 1.0$ N/mm ²	1.10
$\sigma = 2.0$ N/mm ²	1.05
$\sigma = 3.0$ N/mm ²	1.00 ◀
$\sigma = 4.0$ N/mm ²	0.96
$\sigma = 5.0$ N/mm ²	0.92

Temperature	Modulus of elasticity [N/mm ²]	
	1	2
≤ 10°C	$E_{kz} 10^{-1}h$	$E_c 100min$
20°C	1400	1130
30°C	1200	980
40°C	960	780
50°C	770	650
60°C	620	525
70°C	500	430
80°C	400	350
90°C	320	280
100°C	270	235
	225	200

Note:
 Values up to 80°C in Column 1 are from DVS 2205-2 Tab. 6. Numbers in Column 2 are interpolated between $E_{ST} (10^{-1}h)$ and $E_{LT} (1 \text{ year})$.
 Special attention has to be paid to time-dependent thermal ageing regarding calculations of $T \geq 80^\circ\text{C}$.

3.3 Creep modulus for PP-R

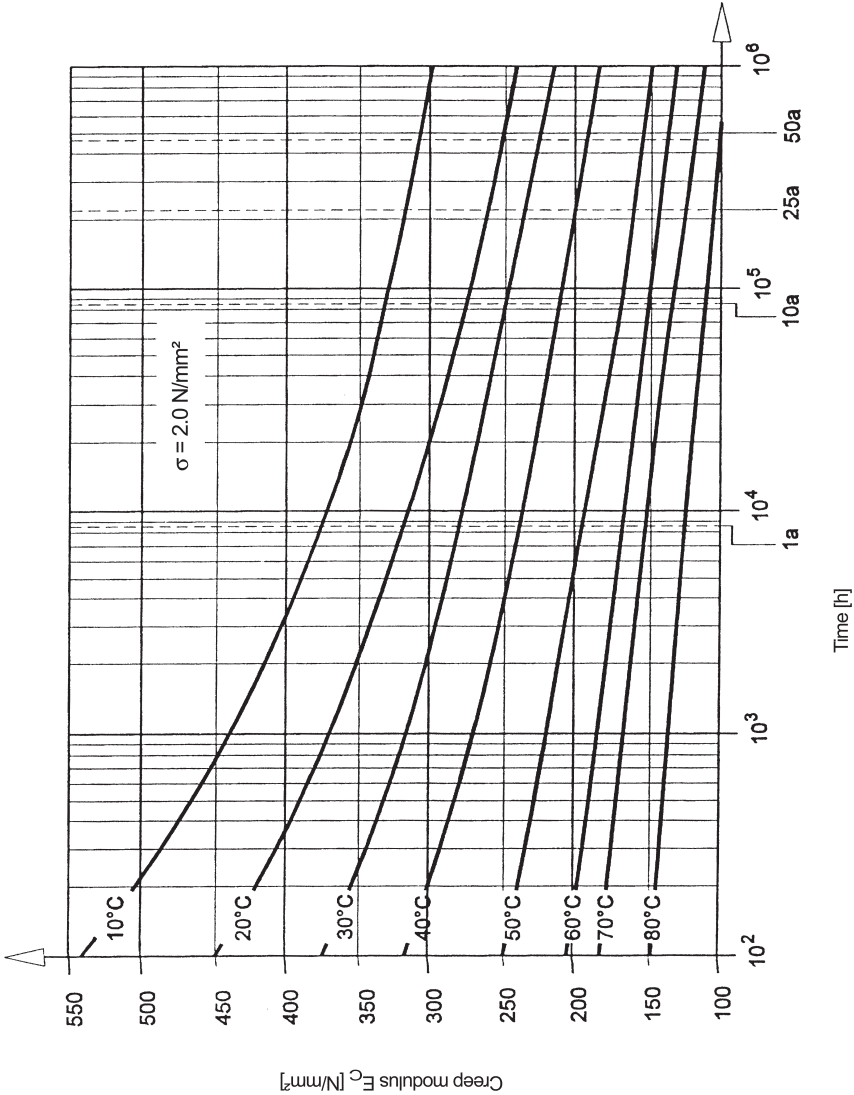

Modulus of elasticity [N/mm ²]		
	1	2
Temperature	E_{kz} 10 ⁻¹ h	E_c 100min
≤ 10°C	1000	800
20°C	800	650
30°C	620	515
40°C	490	420
50°C	380	320
60°C	300	260
70°C	230	210
80°C	180	170

Note:
 Values up to 80°C in Column 1 are from DVS 2205-2 Tab. 6. Numbers in Column 2 are interpolated between E_{St} (10⁻¹ h) and E_{LT} (1 year) according to DVS 2205-1.

3.4 Creep modulus for PVDF

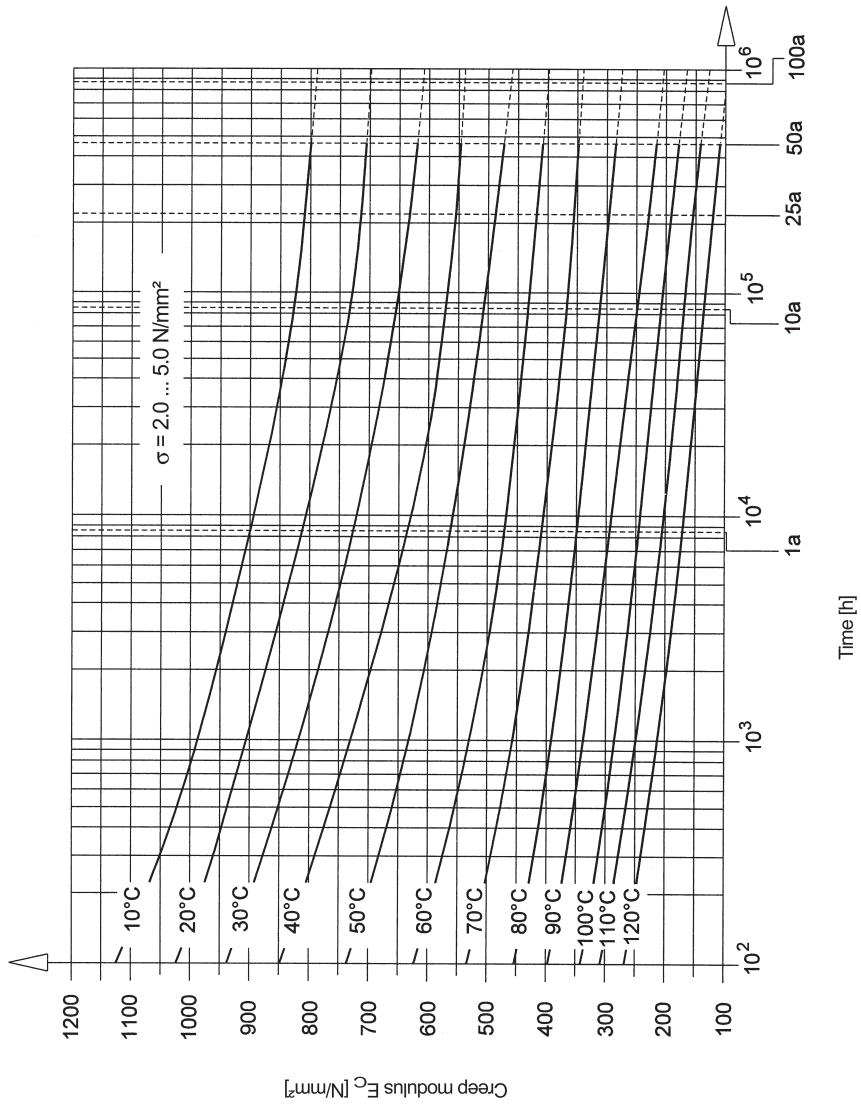

Modulus of elasticity [N/mm ²]		
Temperature	1 E _{cr} 10 ⁻¹ h	2 E _c 100min
≤ 10°C	1900	1540
20°C	1700	1390
30°C	1515	1255
40°C	1330	1110
50°C	1190	980
60°C	1050	850
70°C	935	750
80°C	820	650
90°C	735	570
100°C	650	505
110°C	580	455
120°C	505	395

Note:
 Values up to 80°C in Column 1 are from
 DVS 2205-2 Tab. 6. Numbers in Column 2
 are interpolated between E_{ST} (10⁻¹ h) and
 E_{LT} (1 year) according to DVS 2205-1.

4 Material properties and loading capacities

4.1	Material properties	29
4.1.1	Chemical resistance	29
4.1.2	Radiation stability	29
4.1.3	Fire behaviour	29
4.1.4	Weathering stability	30
4.1.5	Water absorption	30
4.1.6	Physiological acceptability	31
4.1.7	Resistance to rodents and microorganisms	31
4.1.8	Electrical conductivity	31

4.2	Loading capacities	33
4.2.1	Modulus of elasticity and its significance in dimensioning	33
4.2.2	Determining of permissible stresses	34
4.2.3	Internal overpressure example	35
4.2.4	Internal negative pressure or external overpressure example	42

4.1 Material properties

4.1.1 Chemical resistance

The polyolefines PE-HD and PP exhibit very similar chemical resistance. They are resistant against diluted solutions of salts, acids and alkalis.

Up to 60 °C, these materials may be used with many solvents. At high temperatures, they are dissolved by aromatic and halogenated carbohydrates.

PVC pipes are resistant to diluted and concentrated acids and bases, mineral and vegetable oils, alcohol and aliphatic carbohydrates. Aromatic hydrocarbons and chlorohydrocarbons as well as esters and ketones dissolve PVC.

PVDF is resistant to most inorganic chemicals, acids, salts, and alkalis, even in high concentrations and at elevated temperatures. Stability against aliphatic and aromatic hydrocarbons, organic acids, alcohols and aromatics is excellent. Some ketones, hot, highly concentrated alkalis, smoking sulfuric acid, amines and pyridine attack PVDF. Dimethyl formamide and dimethyl acetamide dissolve PVDF.

In choosing the appropriate material for a specific project, the chemical resistance needs to be considered. It depends on the

- medium
- concentration
- temperature
- manufacturing conditions of the finished piece and
- the load.

In the CD SIMONA® SIMCHEM, we have assembled our extensive experience with over 3.000 different media. There you will find detailed answers to your questions.

4.1.2 Radiation stability

The effect of highly energetic radiation on plastics depends only on the dose, not on the kind of radiation; the one exception is heavy ions. Radiation of plastic in air reduces lifetimes appreciably in comparison to radiation with exclusion of oxygen. The only important factor is the dose received; Table 1 gives a guideline. In comparison, the fatal dose for humans is about 0.0006 Mrad. Therefore, wherever people are allowed without restriction, almost any plastic can be used.

Table 1: Permissible Radiation Dosage

Material	Max. dosage ~ Mrad [Ⓞ]	Long-term dosage ~ Mrad [Ⓞ]
PE-HD	10	1
PP	3	0.1
PVC	60	6
PVDF	40	20

[Ⓞ] 10⁴ J/kg = 1 Mrad

4.1.3 Fire behaviour

The DIN 4102 differentiates between

- non-combustible building materials (Class A), and
- combustible building materials (Class B).

Without exception, plastics are Class B. A further differentiation is:

- B1 flame retardant
- B2 ignites normally
- B3 ignites easily.

Further indication for fire behavior is the oxygen index (Table 2, p. 30). This number gives the minimum oxygen concentration of the surrounding air required for steady combustion. A value under 20.8% means that the material can be ignited and continues to burn after the ignition source is removed.

MATERIAL PROPERTIES

Table 2: Fire Behavior Evaluation

Material	Fire behavior acc. to DIN 4102 Class	External ignition temp. ASTM 1929 °C	Oxygen index ASTM 2863 %	Evaluation ^① acc. to UL 94 Class	Evaluation DIN 53438 Class	
PE-HD (PE 80/PE 100)	B2	340	18		F2	K2
PE-EL	B2	340	18		F2	K2
PP-H	B2	345	18		F2	K2
PP-R	B2	345	18		F2	K2
PPs	B1	> 390	28		F1	K1
PVDF	B1	> 390	78	V-0	F1	K1

① Evaluation by SIMONA

4.1.4 Weathering stability

When used or stored outside, most natural and synthetic materials are damaged across the time by weathering, especially by solar UV radiation. Discoloration and degeneration of mechanical properties can render the products less effective.

This applies especially to

- PE-HD natural and coloured (except black)
- PP natural and coloured, e. g. grey
- PPs grey,

unless these materials have been especially stabilized for outside use.

Very good weathering stability without UV stabilizing additives is found in:

- PVDF natural and coloured.

Certain UV stabilizers (special order) may increase the light protection factor of coloured material to four times that of the uncoloured material. Adding some types of black carbon offers further increases.

Together these effects produce excellent weathering stability for

- PE-HD black
- PE-EL black.

4.1.5 Water absorption

The materials

- PE-HD
- PP
- PVDF

are water-repellent. There is no swelling or change in dimensional stability. Tests according to DIN 53495 show a very slight water absorption. This is only from adsorption of traces of surface moisture.

4.1.6 Physiological acceptability

Contact with food

The recommendations of the Federal Institute for Risk Assessment (BfR) in Berlin determine acceptability of materials. A positive list states which substances – sometimes in limited concentrations – an allowed material may contain. The following SIMONA® pipes:

- PE-HD
- PP

are suitable for contact with food.

No judgment has yet been passed by BfR on

- PVDF

However, the raw material manufacturers state that it contains no substances which could affect food negatively.

The materials:

- PE-EL
- PPs

are unsuitable for contact with food.

Contact with drinking water

The KTW (Kunststoff-Trinkwasser-Empfehlungen) recommendations of the BfR determine suitability of plastics to be used with drinking water. The materials approved for food contact also conform to these guidelines, by virtue of their composition. PP pipes may develop a temporary odor.

4.1.7 Resistance to rodents and micro-organisms

Rodents are known to sharpen their teeth on the hardest objects they find. These may be wood, soft metals, or plastics, not inviting in taste or aroma. However, they cannot easily get their teeth into smooth, rounded pipe surfaces. Rodent activity on pipes or on the surfaces of flat pieces is rare.

The pipe materials sold by SIMONA are not suitable substrates for microorganisms (bacteria, fungus, spores) and are not affected by them. This is also true for sulfate-reducing bacteria.

4.1.8 Electrical conductivity

The materials:

- PE-HD
- PP
- PVDF

are, like all other plastics, electric insulators. Any material with a volume resistivity higher than $10^6 \text{ Ohm} \cdot \text{cm}$ is an insulator. The resistivity of these plastics is in the order of $10^{15} \text{ Ohm} \cdot \text{cm}$. The surface resistance is important for the user. If it is higher than 10^9 Ohm , the material is classed as electrostatically chargeable.

In plastic pipeline construction, electrostatic charge is to be avoided when electrically non-conducting media are being transported or the pipeline is to be laid in places with risk of explosion. Transporting ignitable gases or liquids is without risk only if the system is closed and grounded. The static charge danger can be further reduced by reducing the transport speed.

MATERIAL PROPERTIES

Ignitable mixtures can be avoided in spaces where plastic pipelines are to be laid, by venting or by an exhaust system. Another possibility is to ionize the air and avoid the electrostatic charge on the plastic. Since above 65% relative humidity electrostatic charging hardly occurs, raising the humidity often solves the problem.

Generally, it is possible to produce non-conductive plastics with appropriate additives. This must happen in the manufacture; conductivity cannot be retrofitted. Pipes of electrically conducting PE 80, the SIMONA® PE-EL, is standard stock for our company, available in many sizes.

Special orders are taken for pipes of electrically conducting PP and PVDF, for sufficient volume. Please ask us about these materials as required.

4.2 Loading capacities

4.2.1 Modulus of elasticity and its significance in dimensioning

The modulus of elasticity E is a material constant and expresses the relationship between stress σ and strain ϵ in a component. It is determined experimentally with a load along one axis. The test sample can be subjected to pure tension or to a bending load. The elastic modulus has the same units as stress and can be interpreted as the slope of HOOKE lines in a stress-strain diagram (σ - ϵ -diagram).

HOOKE's law for one-dimensional stress is:

$$\sigma = E \cdot \epsilon,$$

Rearranging, the elastic modulus is:

$$E = \frac{\sigma}{\epsilon}.$$

The value of the elastic modulus is that knowing the load or tension on an object, the resulting deformation can be calculated. Vice versa, knowing the deformation from a strain gauge, the tension or load on the object can be found.

Time-dependent modulus of elasticity (creep modulus)

The elastic modulus is useful for metals. For thermoplastics, the creep modulus E_c , depending on time, temperature, and tension, is the analog. The creep modulus is also, like the elastic modulus, the quotient of tension and elongation. For plastics, the proportionality factor between stress and strain in HOOKE's law is a constant elastic modulus only for short times. For longer times, that factor is the time-dependent creep modulus, the ratio between the constant applied stress and the increasing elongation.

The manner of calculating an permissible creep modulus for a particular dimensioning with thermoplastics is similar to the manner of calculating stress. Besides time and temperature dependence, the influence of

the transported material and the stress dependence must also be considered; and a safety factor must be included when calculating an permissible (design) creep modulus.

For calculations with the creep modulus, the way of loading (tension or bending) has to be considered; as creep moduli for these two cases are different. An elastic modulus for tension is larger than for bending loads.

Differentiation between elastic and creep modulus

For loads that are applied for a short time, only the short-time elastic modulus E_{ST} is to be used, while for those loads of long duration, the long-time elastic modulus E_{LT} i. e. the creep modulus E_c , is required. The creep modulus is the relevant parameter for deformation calculations, especially for sagging of pipes, e. g. between supports (support distance).

For calculations of pipe denting under negative internal pressure, the short-time elastic modulus E_{ST} is to be used, because the denting process is a sudden (short-time) event leading to pipeline instability. For the relevant values of this short-time modulus, please refer to the tables in the SIMONA diagrams, sec. 3.1 to 3.4 (pp. 23–26). Sec. 4.2.4 demonstrates how to calculate denting safety.

Buckling of a pipeline under axial pressure depends on the guide distances and the condition (e. g. previous bending) of the pipe. The elastic or creep modulus is not important for this. Details about determining pipe guide and mounting distances can be found in sec. 5.3.

A further dimensioning criterion where the creep modulus plays a role is the anchor load when a pipeline is axially mounted (see sec. 5.3). When calculating

the anchor load, assume that temperature fluctuations in the piping system require some time to produce changes in length. If length changes are suppressed by anchors, internal pressure or tension results, depending on the creep modulus and the temperature.

In these calculations, the creep modulus value for $t = 100 \text{ min}$ [$E_{C(100 \text{ min})}$] goes into the equation for the anchor load. Values for $E_{C(100 \text{ min})}$ are found in the tables of the SIMONA diagrams, sec. 3, pp. 23–26. An example for finding the anchor forces is in section 10 (Explanation [6] and [7]).

The material-dependent creep modulus for thermoplastics PE-HD, PP, and PVDF can be taken from the SIMONA creep modulus diagrams for a given temperature and duration between 100 hours and 100 years, from the corresponding averagevalue curve.

Determining an permissible elastic or creep modulus

When determining an permissible (design) elastic or creep modulus for a specific application, the influence of the transported material must be considered, in addition to temperature, time, and stress dependence. To compensate for uncertainties in operating conditions, an adequate safety factor must be included. Recommended safety factor is $S \geq 1.1$.

There results (see section 10 Explanations [1]):

$$\text{per } E_{C(ST,LT)} = \frac{E_{(T,t,\sigma)}}{A_2 \cdot SF}$$

where:

per $E_{C(ST,LT)}$ = permissible creep modulus for short/long time [N/mm²]
 $E_{(T,t,\sigma)}$ = creep modulus from SIMONA diagram, sec. 3.1 – 3.4 [N/mm²]
 A_2 = reduction factor for transported substance[Ⓢ] [-]
 SF = safety factor to avoid ultimate elongation (e.g. according to DVS 2205 part 1, table 1) [-]

Ⓢ The value of the reduction factor A_2 can be taken from SIMONA® SIMCHEM or the DIBt substance list.

4.2.2 Determining of permissible stresses

Tensile strength calculations for plastic pipelines always have to use the long-time parameter. They must be related to the theoretical minimum duration (lifetime) of the pipeline. Customary values are:

- 10 years: Containers and apparatus in industrial construction
- 25 years: Pipelines in industrial construction
- 50 years: Pipelines for public utility supply lines.

In special cases, the calculation may be made for shorter durations. The operator of the pipeline must give his explicit approval for such a case. It is not permissible to reduce the nominal lifetime for facilities which store, bottle, or process substances hazardous to water (called LAU plants).

Material constants from compression stress-time curves

Tensile strength values for thermoplastic containers and pipelines can be taken in relation to the operating temperature from the SIMONA internal pressure creep curves or the basic pipe standards as well as the guidelines DVS 2205-1 with their supplements. Using the creep diagrams, the parameters for a specified temperature and time can be obtained from a minimum curve. The tensile strength value K is usually related to an uni-axial load at 20°C, e.g. the ultimate deformation of steel under tension.

The creep diagrams for thermoplastics show the strength of unfused pipe under internal pressure (two-axis load), and the curves show the equivalent stress σ_v . How to use the creep diagrams will be clarified in the next example.

Calculating permissible stress

The permissible stress for strength-dependent dimensioning of thermoplastic pipelines is based on the equivalent stress σ_v found from the internal pressure creep curves. The permissible hoop stress is determined as follows (see section 10 Explanations [2]):

$$\sigma_{\text{per (h)}} = \frac{\sigma_v}{A_2 \cdot A_4 \cdot \text{SF}}$$

where:

$\sigma_{\text{per (h)}}$	= permissible hoop stress ^①	[N/mm ²]
σ_v	= equivalent stress from the creep diagrams	[N/mm ²]
A_2	= reduction factor for transported substance ^②	[-]
A_4	= reduction factor for material strength	[-]
SF	= safety factor	[-]

① for the temperature and time selected.

② The value of the reduction factor A_2 can be taken from SIMONA® SIMCHEM or the DIBt list.

Note: For the hoop stress, the joint or welding factor for the pipe welding has no effect, because the stress direction is parallel to the joint plane. For axial stress, e.g. tension or bending load, the joint factor f_s must be taken into account, because the stress is then vertical to the joint plane.

For those cases, the joint factor is put into the equation so that the equivalent stress is effectively reduced by that factor $f_s < 1.0$. Then the permissible longitudinal stress (tension or compression) is (see section 10 Explanations [2]):

$$\sigma_{\text{per (l)}} = \frac{\sigma_v \cdot f_s}{A_2 \cdot A_4 \cdot \text{SF}}$$

where:

$\sigma_{\text{per (l)}}$	= permissible longitudinal stress	[N/mm ²]
f_s	= joint or welding factor	[-]

For details about determination of the various factors and coefficients, refer to Guideline DVS 2205-1.

4.2.3 Internal overpressure example

In most cases, pipelines are under internal overpressure. Data on permissible internal pressure loads of thermoplastic pipelines for varying operating temperature and time are found in the basic pipe standards. When a pipeline is subjected to internal overpressure, the pipe cross section is subjected to hoop and longitudinal (axial) stress. Looking at the stress magnitudes, it turns out that the hoop stress is about twice as high as the longitudinal.

For this reason, the dimensioning of pipe of any material under internal overpressure is based on the permissible hoop stress. The following SIMONA diagrams (pp. 37 etc.) show graphically how the permissible internal pressure decreases with increasing operating temperature, i.e. it is temperature-dependent.

Note that the permissible operating overpressure in the diagrams is given only for a theoretical lifetime of 25 years. If the pipeline is laid out for a different lifetime at the same temperature, the operating overpressure must be changed. The required data are found in the basic standards for each pipe material.

A 25-year lifetime is usual for industrial pipelines. For public supply lines, e.g. gas and water, lifetimes are ≥ 50 years. The difference is essentially that industrial pipelines seldom operate at even temperatures. By contrast, drinking water pipelines operate at a nearly constant temperature of between 10 °C and 20 °C. This automatically increases the lifetime, for nominal pressure load.

Despite higher operating temperature and the frequent temperature fluctuations, an industrial pipeline must be able to assure safe transport of the transported substance for a period of at least 25 years.

LOADING CAPACITIES

When using SIMONA diagrams, note that the lifetimes are for pipelines that carry water and other substances that do not affect the mechanical properties of the pipe material. The effect of the transported substance on the pipe material is determined under laboratory conditions and reflected in a reduction factor A_2 . Notes on the A_2 factor are found in SIMONA® SIMCHEM (see section 10 Explanations [3]).

Permissible loads for plastic pipelines under internal overpressure
Material: PE 80
SDR 41/33/26/17.6/11/7.4
SF = 1.25

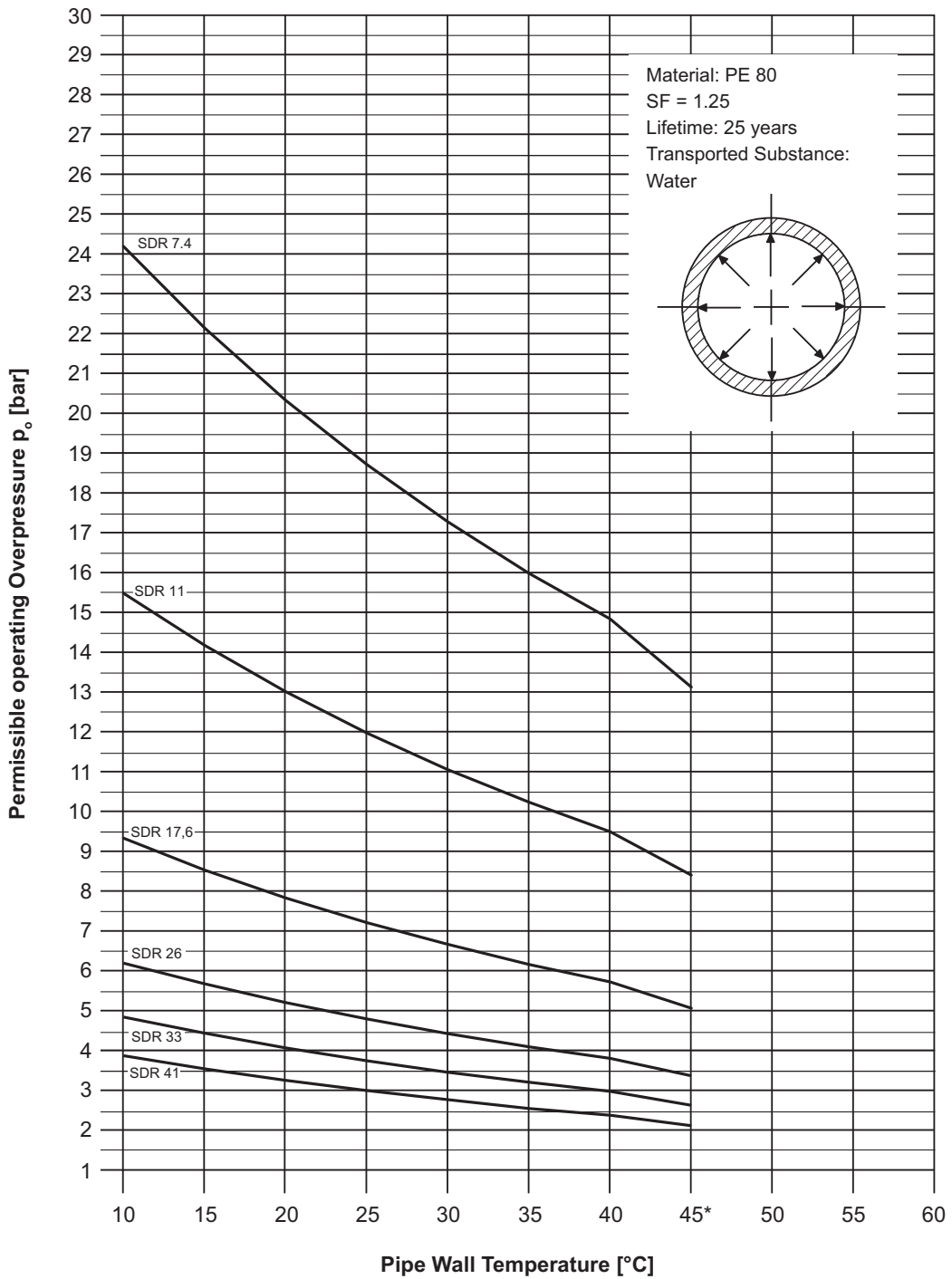

Note: Higher temperatures possible for decreased lifetimes (see DIN EN 8074)

* Service life temperature limit at 25 years due to thermal ageing (effects related to thermooxydation)

Permissible loads for plastic pipelines under internal overpressure
Material: PE 100/PE 100 RC
SDR 41/33/26/17/11/7.4
SF = 1.25

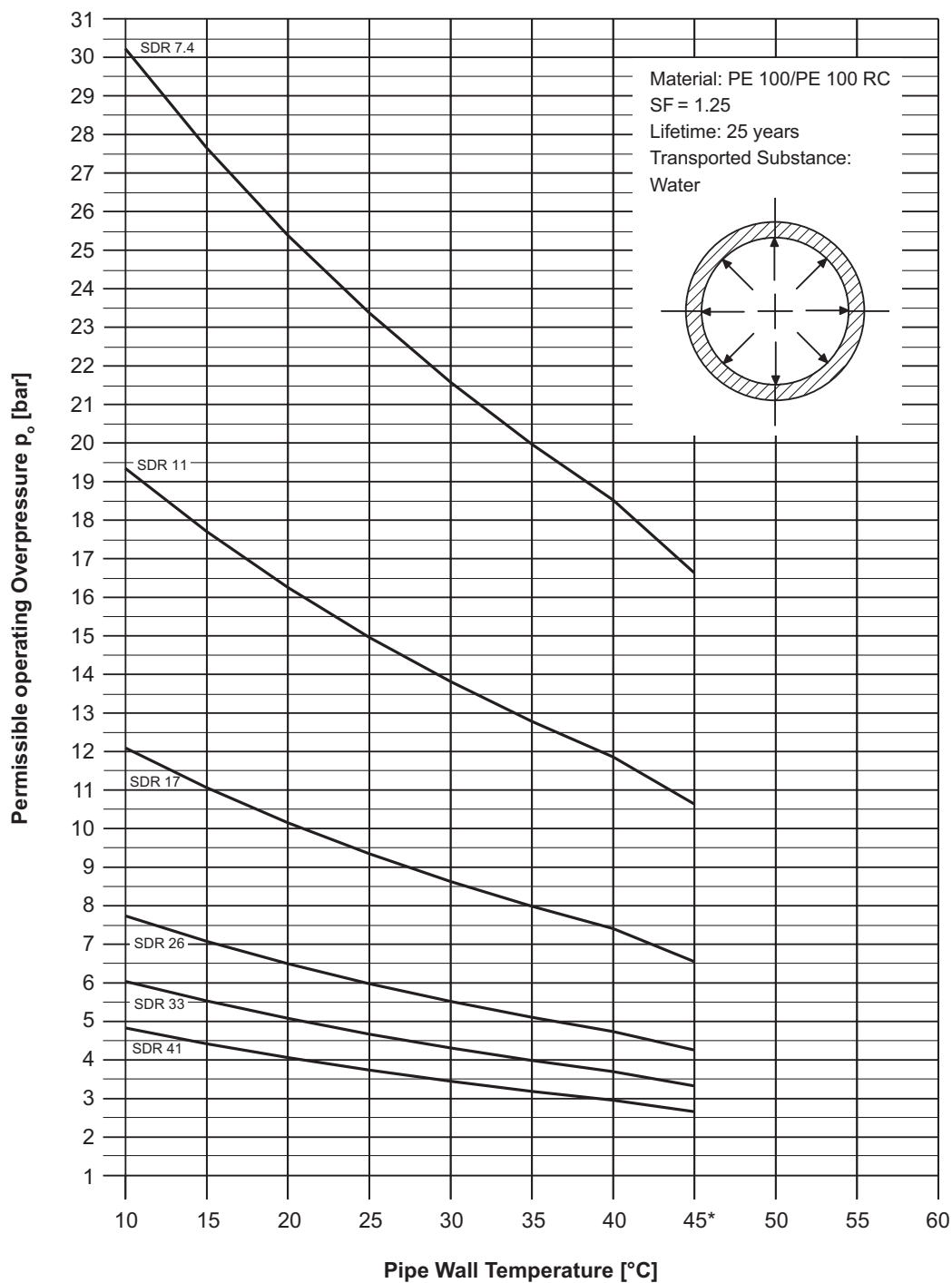

Note: Higher temperatures possible for decreased lifetimes (see DIN EN 8074)

* Service life temperature limit at 25 years due to thermal ageing (effects related to thermooxydation)

Permissible loads for plastic pipelines under internal overpressure
Material: PP-H
SDR 41/33/26/17.6/11/7.4
SF = 1.25/1.4/1.6

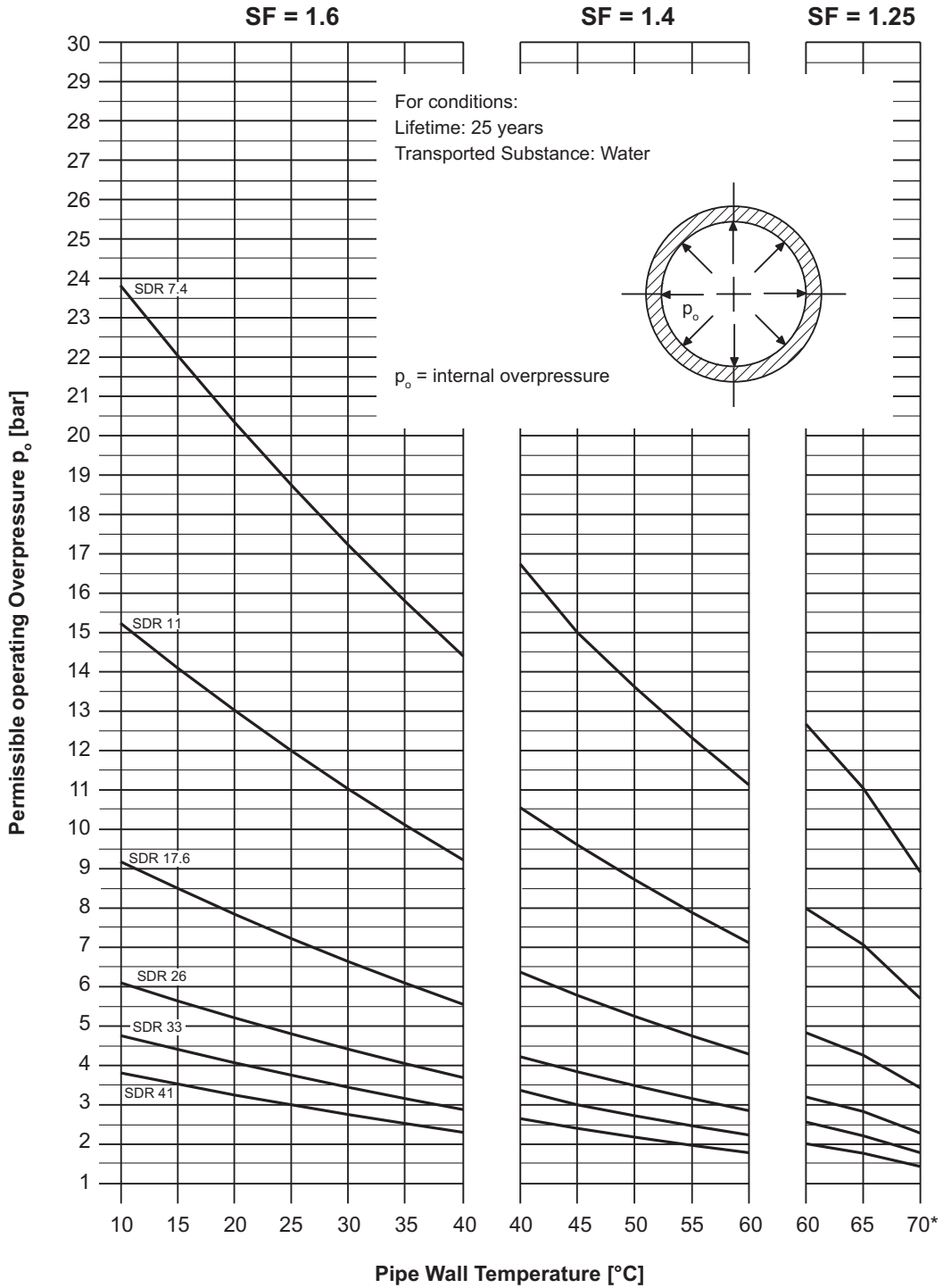

Note: Higher temperatures possible for decreased lifetimes (see DIN EN 8077)

* Service life temperature limit at 25 years due to thermal ageing (effects related to thermooxydation)

Permissible loads for plastic pipelines under internal overpressure
Material: PP-R
SDR 41/33/26/17.6/11/7.4
SF = 1.25

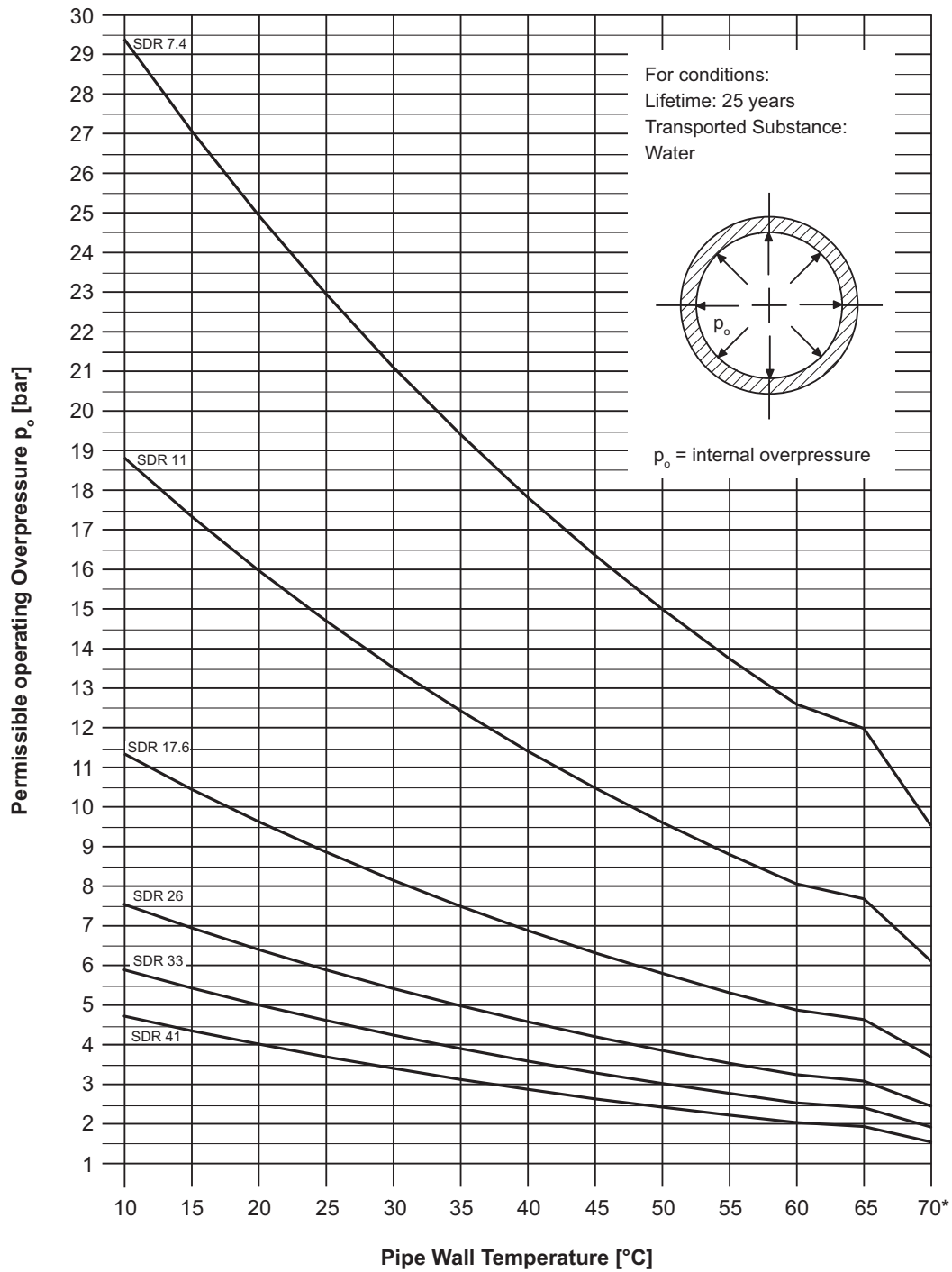

Note: Higher temperatures possible for decreased lifetimes (see DIN EN 8077)

* Service life temperature limit at 25 years due to thermal ageing (effects related to thermooxydation)

Permissible loads for plastic pipelines under internal overpressure
Material: PVDF
SF = 1.6

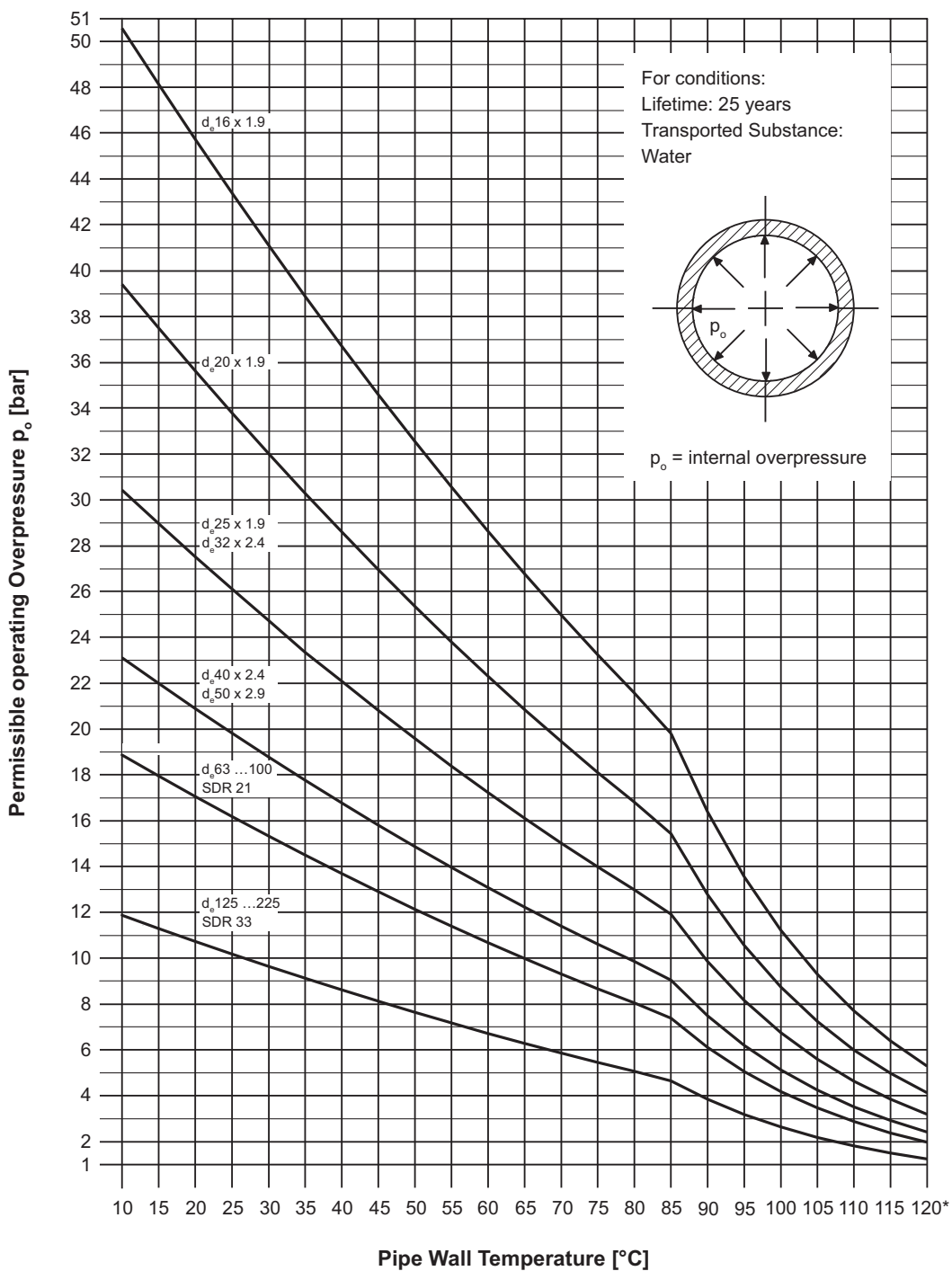

Note: Higher temperatures possible for decreased lifetimes (see DIN EN ISO 10931)

* Service life temperature limit at 25 years due to thermal ageing (effects related to crystallinity upon approaching the melting point)

4.2.4 Internal negative pressure or external overpressure example

For pipelines under negative (low) internal pressure, respectively external overpressure, the pipe wall tends toward elastic buckling. If loads are large enough, plastic deformation may occur.

The example of buckling does not exactly involve a consideration of strength, but rather more a stability criterion: the pipeline undergoes a short-time failure in the radial direction. The basic standards and guidelines for pipes contain no data on permissible negative pressure loads.

Under negative pressure, the pipe cross-section comes under stress in the hoop, longitudinal, and radial directions. The stress direction is opposite to what occurs for internal overpressure.

The maximum internal negative pressure is the atmospheric pressure ($p_o \leq 1033$ mbar), so the stresses are small. By contrast, external overpressure can be larger for pipelines e.g. under water. Stress calculations are not usually carried out, since as a rule failure occurs through instability of the cylindrical shell. Investigating the stress between struts is only necessary for thin-walled ventilation ducts.

In the case of axially restrained pipe, additional pressure stress from suppressed thermal movement will be superimposed on the longitudinal stresses (pressure stresses) from internal low pressure or external overpressure. This increases the risk of instability (buckling) as compared to axially free pipe runs.

For these reasons, pipe dimensioning for negative pressure loads concentrates almost exclusively on verification of buckling safety. The buckling safety factor is defined by:

$$S_{\text{buck}} = \frac{p_{\text{crit}}}{p_{\text{rate}}} \geq 2 \text{ } \textcircled{1}$$

where:

- p_{crit} = external pressure – internal pressure difference for which buckling begins (critical buckling pressure) [mbar, bar]
- p_{rate} = internal negative pressure or external overpressure that pipeline could be subjected to [mbar, bar]

$\textcircled{1}$ If the verification calculation does not take the pipe's deviation from perfect roundness explicitly into account, S_{buck} should be set ≥ 2.5 .

The critical buckling pressure for long pipes (pipe runs) for negative pressure or external overpressure is given, almost exactly, by the equation (see section Explanations [4]):

$$p_{\text{crit}} = \frac{2 \cdot E_{\text{ST}}}{1 - \mu^2} \cdot \frac{e^3}{d_o^3} \cdot 10$$

where:

- p_{crit} = critical buckling pressure [bar]
- d_o = outer pipe diameter [mm]
- e = pipe wall thickness [mm]
- E_{ST} = short-time elastic modulus at max T_{op} [N/mm²]
- μ = cross contraction (Poisson) ratio = 0.38 [-]
- 10 = conversion factor from [N/mm²] to [bar]

The following SIMONA diagrams in this section (pp. 44–48) show the permissible internal negative pressure load for axially restrained pipe runs. No separate case for axially unrestrained pipe has been given, since it cannot always be ascertained whether the pipe was laid with longitudinal freedom of motion.

All curves clearly show that the permissible negative pressure depends on operating temperature (pipe wall temperature). It does not depend on lifetime, since buckling can happen at any time. For buckling, the most important quantities are the negative pressure, whether continual or sudden, and the short-time elastic modulus for the maximum operating temperature.

When calculating the case of internal negative pressure/external overpressure, the sum of the axial stresses is to be compared to the allowed stress. The combination of axial and radial pressure is evaluated with an interaction condition.

The SIMONA diagrams for estimating the permissible negative pressure load of thermoplastic pipelines are intended as an aid when planning. They do not replace a calculation, which is especially important for axially restrained pipe with small wall thickness (large SDR). The example will clarify the application (see section 10 Explanations [4]).

Load capacity of plastic pipelines under negative pressure
Material: PE 80
SDR 41/33/26/17.6
SF = 2.0

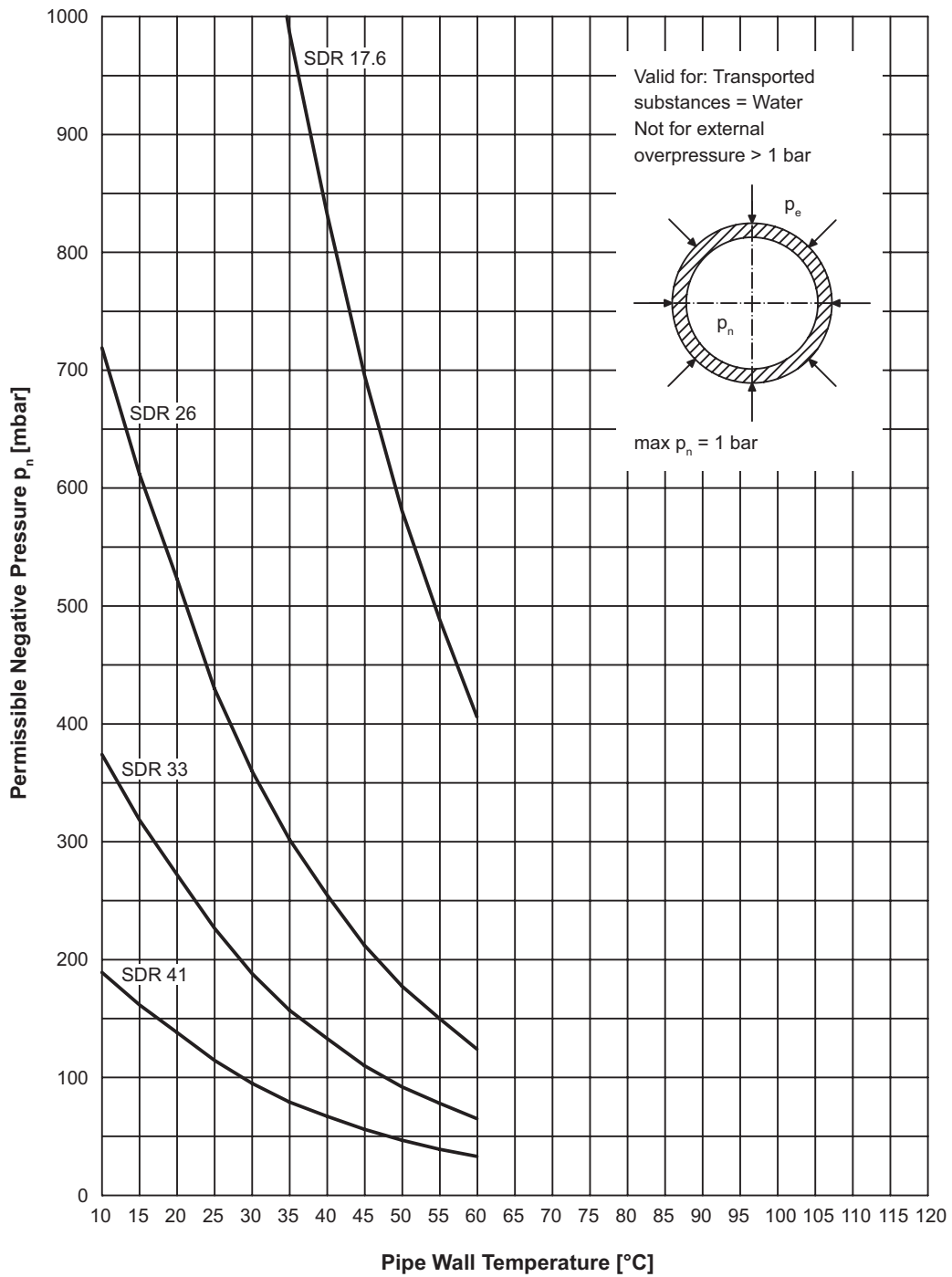

1 mbar = 100 Pa
 p_e = external overpressure
 p_n = internal negative pressure

Load capacity of plastic pipelines under negative pressure
Material: PE 100/PE 100 RC
SDR 41/33/26/17
SF = 2.0

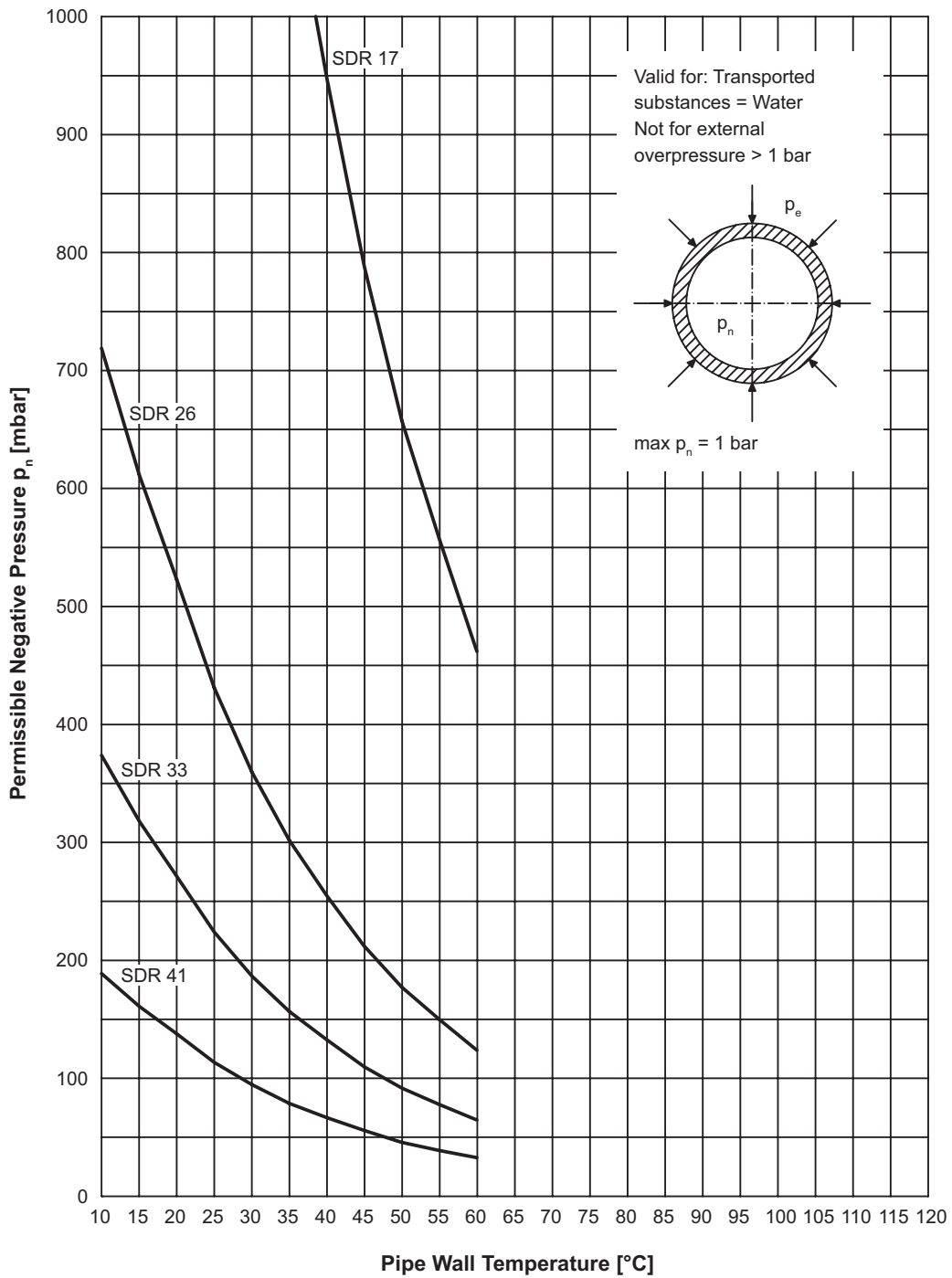

1 mbar = 100 Pa
 p_e = external overpressure
 p_n = internal negative pressure

Load capacity of plastic pipelines under negative pressure
Material: PP-H
SDR 41/33/26/17.6
SF = 2.0

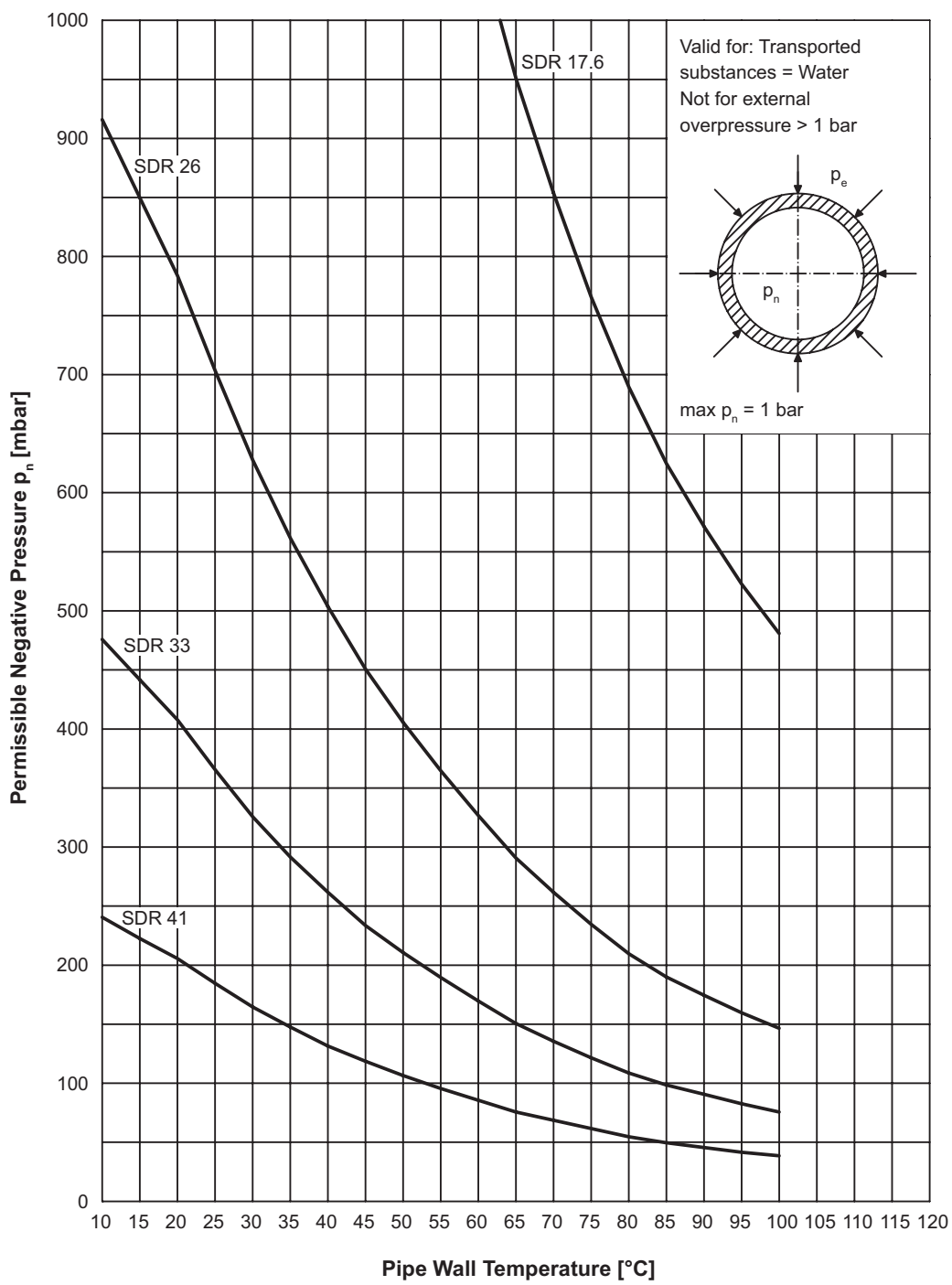

1 mbar = 100 Pa
 p_e = external overpressure
 p_n = internal negative pressure

Load capacity of plastic pipelines under negative pressure

Material: PP-R
SDR 41/33/26/17.6
SF = 2.0

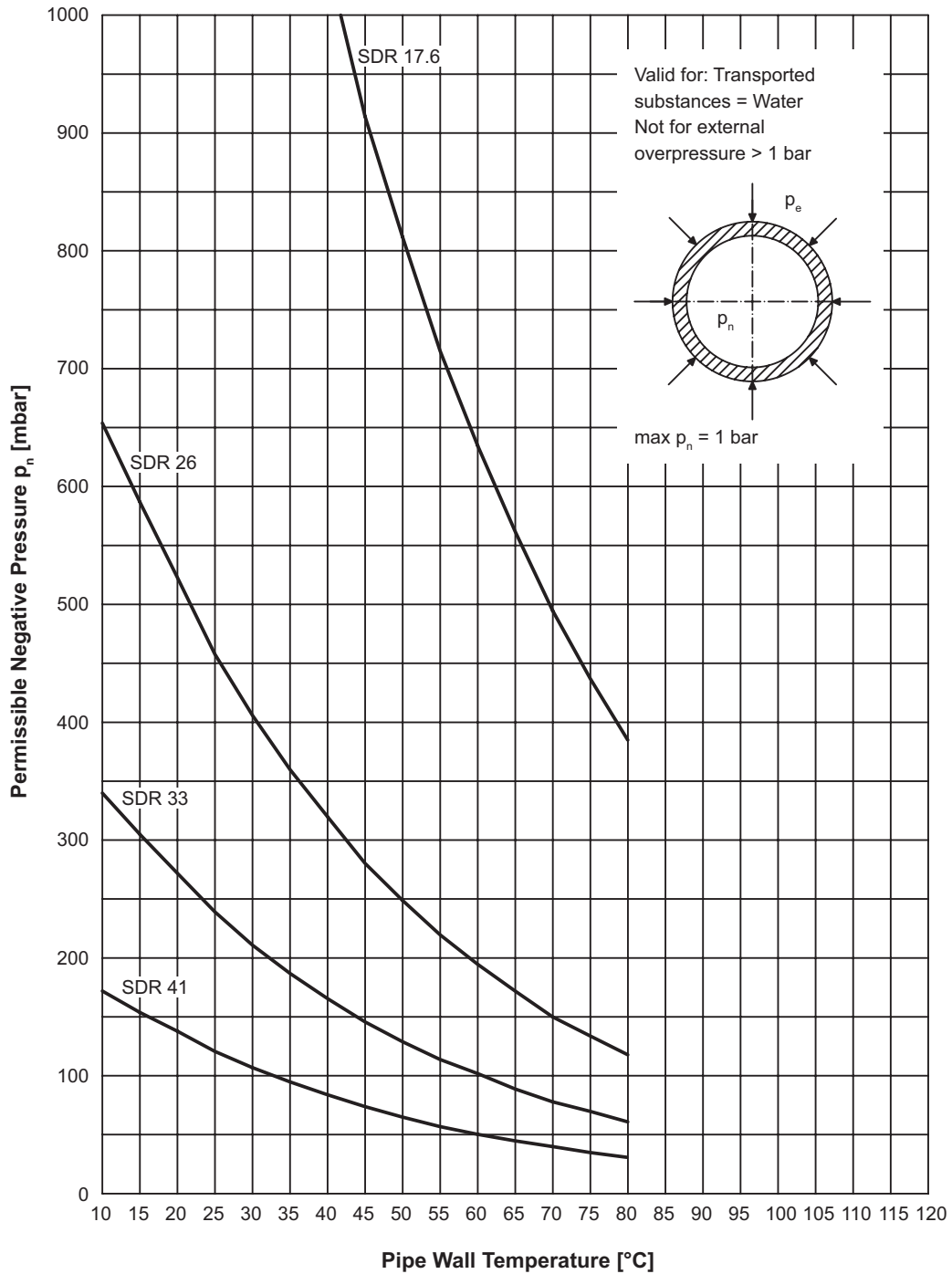

1 mbar = 100 Pa
 p_e = external overpressure
 p_n = internal negative pressure

Load capacity of plastic pipelines under negative pressure
Material: PVDF
SDR 33/21
SF = 2.0

Note: On account of high load stresses the use of longitudinal fixed pipelines made of PVDF at $T_{op} > 80^{\circ}\text{C}$ is not recommended

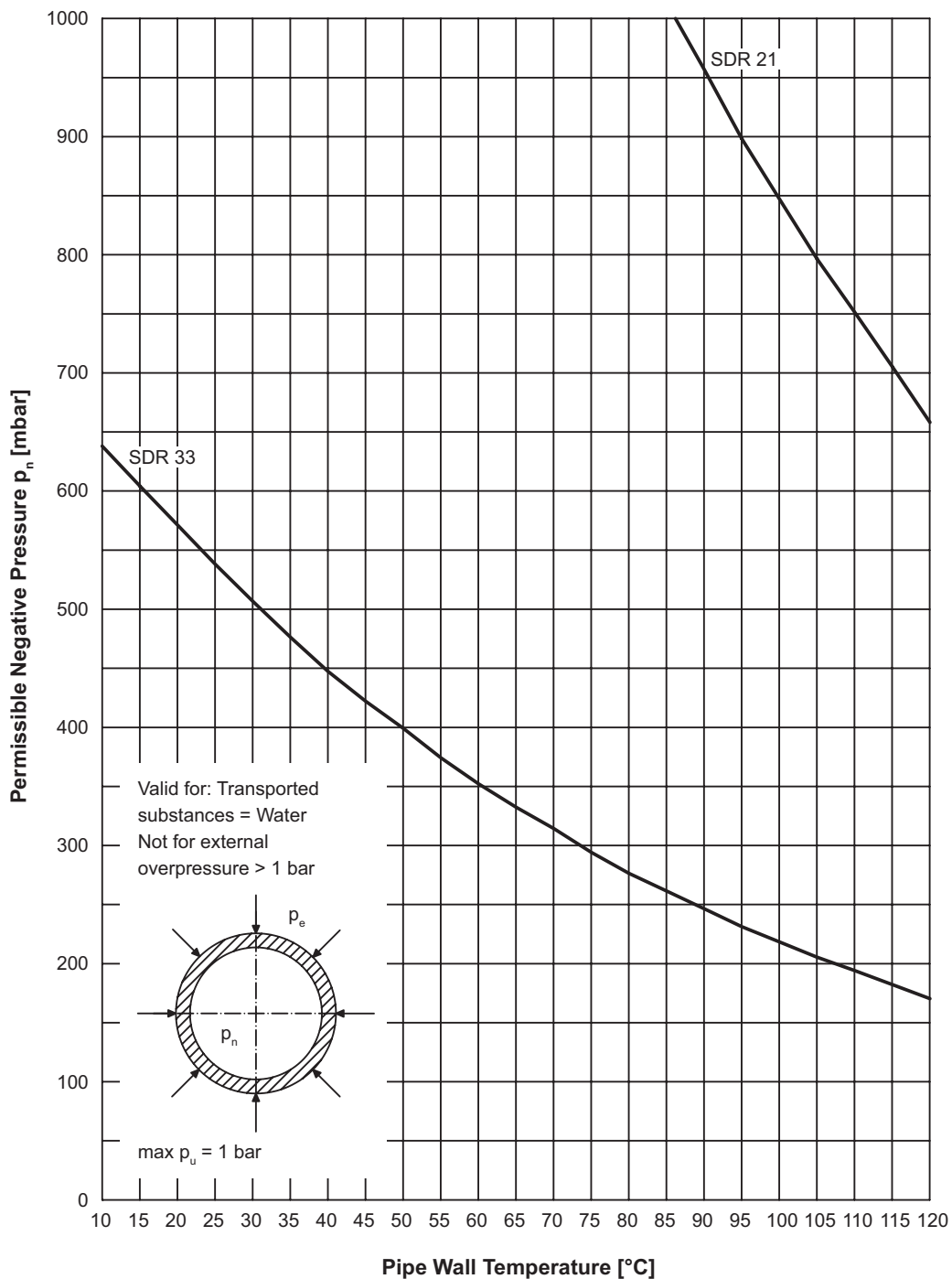

1 mbar = 100 Pa
 p_e = external overpressure
 p_n = internal negative pressure

Load capacity of plastic pipelines under negative pressure
Material: PPs flame retardant (ventilation duct)
SF = 3.0*

max $p_n = 1$ bar
 p_e = external overpressure
 p_n = internal negative pressure

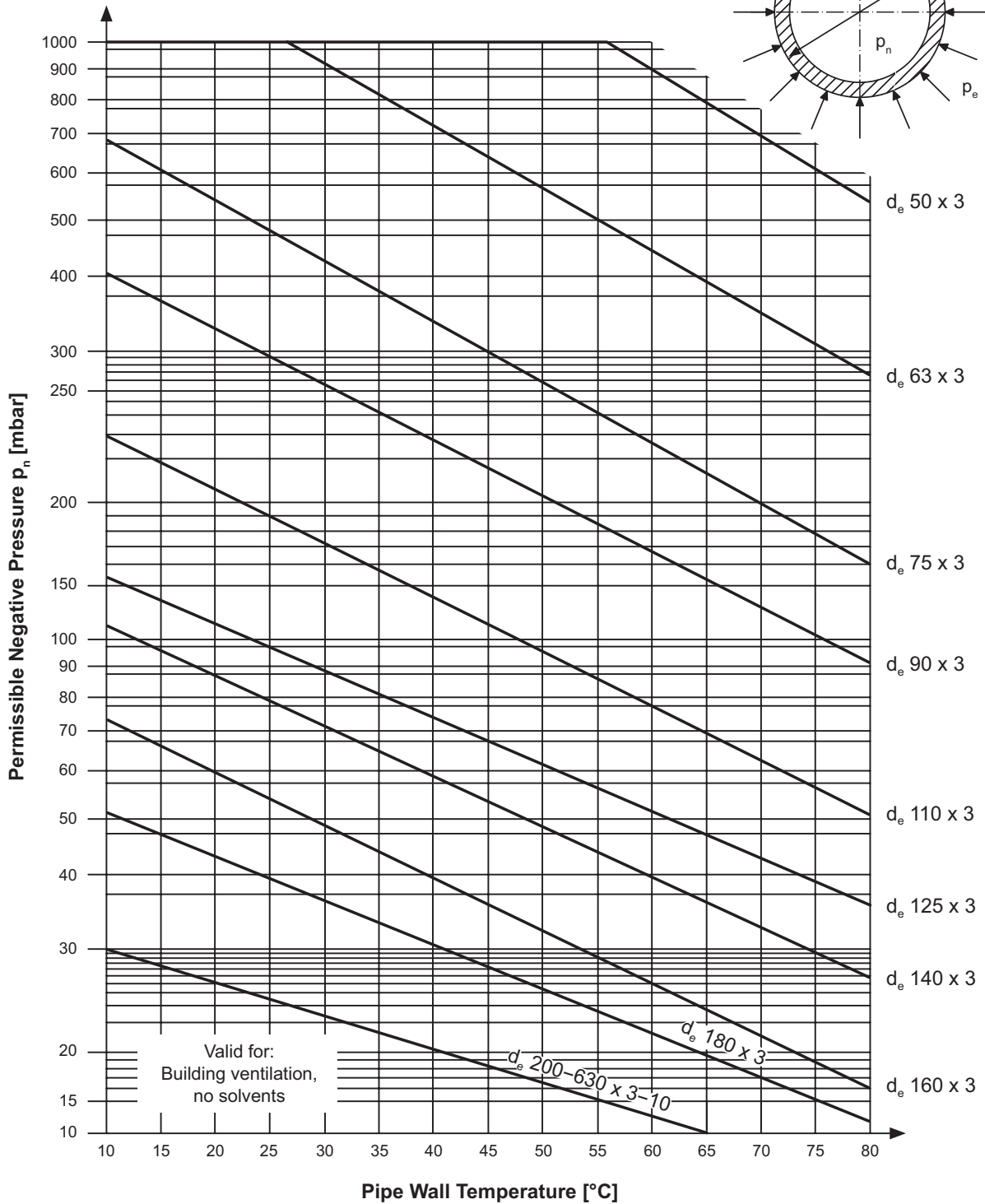
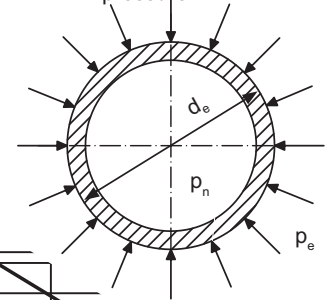

Valid for:
 Building ventilation,
 no solvents

1 mbar = 100 Pa

* Dimensioning following DIN 4740-1

5 Laying, mounting and pressure test

5.1	Transportation and storage	51
<hr/>		
5.2	Burying pipelines	52
<hr/>		
5.3	Laying plastic pipes above ground	53
5.3.1	Installing a plastic pipeline	53
5.3.2	Determining of length changes	56
5.3.3	Pipe components to take up length changes	57
5.3.4	Loads on anchors	82
5.3.5	Distance between mounting devices	87
<hr/>		
5.4	Testing	93
5.4.1	Testing plastic pressure pipelines	93
5.4.2	Testing plastic pipelines not working under pressure	93

5.1 Transportation and storage

The pipeline components are to be transported in appropriate vehicles. Loading and unloading must be carried out with appropriate care. If the loading operations are carried out using lifting equipment, special attachment devices must be used. It is prohibited to throw the pipeline parts down from the loading level. Pipes should be supported along the entire length, if possible. Sudden impact should be avoided. This must be observed especially at low temperature and with materials whose impact resistance is significantly reduced at low temperature.

It is imperative that the storage area for the pipes is stone free and flat. The support and the stacking height must be chosen in such a way that no damage or permanent deformation can occur. In general, stockpiles should be lower than these limits [Pipe with wall thickness \leq SDR 26 (PN 4) should be 0.5 m lower. The piles must be well secured.]:

- PVDF, PP 2.0 m
- PE 80/100 1.5 m

During handling, avoid dragging on the ground. Scratches and marks may not be deeper than 10% of the pipe wall thickness.

The influence of the weather on the stored pipeline parts must be reduced to a minimum. The measures to be taken to this end include preventing the exposure of pipes and fittings to direct sunlight. Furthermore, it must be borne in mind that one-sided heat absorption due to exposure to sunlight may lead to axial deformation of the thermoplastic pipes.

5.2 Burying pipelines

Supports and foundation preparation are the key to a solidly constructed sewer system. The soil at the bottom of the ditch and the backfill must be free of stones and compressible material. In rocky, stony subsoil, the ditch is to be dug at least 0.15 m deeper, the soil removed, and replaced by a layer without stones, e.g. sand or fine gravel. For normal subsoil, 0.1 m is sufficient. If needed, a finely crushed material (e.g. sharp sand) up to 5 mm grain size may be brought in. If using sharp split stone under the pipe, it is necessary to protect the polyethylene pipe surface by a pipe-laying fabric or other special outer covering.

These procedures are recommended in the guidelines for laying and inspecting sewer lines and systems in DIN EN 1610, and the pipelaying instructions for PE-HD sewer pipe from the Plastic Pipe Association, Bonn, Germany (KRV).

For particular cases, SIMONA can draw up a pipeline static calculation fulfilling the requirements of ATV-A 127.

Permissible minimum bending radii

Thermoplastic materials are usually considered as elastic materials, i.e. they can be laid to varying degrees depending on the laying temperature, and often fittings and welds can be reduced. In addition to the laying temperature, the wall thickness and pressure rating of the pipe must be taken into account. The following tables apply to materials that are laid underground.

Bending radii for pipes made of PE 80/PE 100, PP-H

Material	Laying temperature		
	≥ 0 °C	~ 10 °C	~ 20 °C
PE 80/PE 100	50 x d _a	35 x d _a	20 x d _a
PP-H	75 x d _a	50 x d _a	30 x d _a

Factor for increasing the bending radius in pipes with a small pressure load

SDR class	Increase in bending radius
SDR 7.4, SDR 11, SDR 17 and 17.6	x 1.0
SDR 26	x 1.5
SDR 33	x 2.0
SDR 41	x 2.5

5.3 Laying plastic pipes above ground

5.3.1 Installing a plastic pipeline

Plastic pipelines can be laid above or below ground. For underground pipe-laying the pipeline is placed on a continuous bed of sand, which acts as a continuous support structure.

When laying plastic pipelines above ground, it is necessary to use supports, bearing structures, and mountings. The mountings must support, guide, and constrain the pipeline at appropriate intervals.

Mountings can take varying kinds of load as required by the pipe system. Support blocks, for example, are mainly subject to vertical loads from weight of the pipeline. Depending on how the mounting is constructed, horizontal loads can be accepted as well.

Vertical loads

Vertical loads result from the weight of all pipeline components, including valves and fittings, the material in the pipes, and additional weight. Pipeline laid outside can sometimes have snow load.

Horizontal loads

Friction forces

The common cause of horizontal loads is thermal expansion in the plastic pipeline. When a run of pipes moves with rising and falling temperature, there is resistance (friction) on the sliding surfaces of the mounting assemblies. The friction force magnitude depends on the amount of weight on the sliding surface and on the coefficient of friction of the pair of surfaces. The shape of the surface has no effect on the load. With metal attachments, no slide faces should be used, because of corrosion reasons.

Wind forces

Another kind of horizontal load comes from wind, e.g. for pipelines on pipe bridges. The magnitude of horizontal load depends on these factors:

- pipe diameter
- the specific wind pressure
- pipe mounting intervals.

For details of determining wind forces, refer to DIN 1055-4.

Forces arising from installation mode

Thermoplastic pipelines may be installed with or without the freedom to expand axially. The forces arising, and thus transferred to the mountings, are of different magnitudes in the two cases.

Forces in axially movable pipelines

It is always necessary to consider the axial friction forces. A pipeline is seldom one straight run, but usually contains bends and branching. Where direction changes, some pipe near the bend or junction is displaced perpendicular to the axis because of length changes. Friction from the sideways motion and deformation of the bending pipe generates a resistance. The deforming force is smaller, the longer the pipe section moved sideways. However, the side friction force increases with the length of the bending pipe section.

Forces in axially fixed pipelines

Straight pipeline runs whose axial length must be kept within limited space can be constrained with anchors. The forces at anchors, resulting from restraining the axial expansion/contraction, are usually the highest forces on the pipeline.

A load just as high occurs when a long, axially movable pipe run develops a so-called “natural anchor” from the cumulative friction forces. In both cases, the anchor forces must be determined by calculation or else by using the SIMONA Diagrams in sec. 5.3.4.

Anchor dimensioning

Forces at an anchor are both horizontal (x-, y-axes) and vertical (z-axis). With their large loads, anchors almost always demand special construction. The horizontal loads parallel and perpendicular to the pipe axis, in conjunction with the distance of the forces to the mounting plane, generate an additional moment. The effect of the moment on the components of the anchor construction can vary. The mounting hardware (screws, bolts or pegs) are subject to tension, compression, and shear stress, whereas the welded or screwed components are subject to bending, and must be dimensioned (profile and wall thickness) to withstand it.

Anchors must be dimensioned for all loads from assembly, test requirements, and operating conditions. In vertical pipelines, the anchors are additionally burdened by the weight of the pipeline and the dynamic loads (e.g. forces from water changing direction in pipe).

With the sizable forces and the moments to be absorbed, it is imperative to calculate anchors. All bearing components must be considered, and the required cross sections and permissible stresses verified. The anchor force magnitudes can be taken from sec. 5.3.4.

Principles for fastening plastic pipelines

Pipeline mountings must be capable of accepting all loads that a pipeline places on its surroundings and safely transferring them onto a building or support

system. Because plastic pipelines have limited and temperature-dependent strength and shape stability, the requirements on their mounting system are different from those for metal pipelines.

Here we describe the basis for constructing mounting systems properly suited to demands of plastic pipelines.

Slide plate assembly

A slide plate assembly is intended to offer the least possible resistance to the expansion and contraction occurring in normal operation. Pipe sliding must be possible both in the longitudinal direction and perpendicular to it. When used with horizontal pipes, the assembly can only accept vertically directed (weight) forces.

Pipe guide (directional anchor)

A guide prevents sideways pipe movement. Besides weight load, it must be able to accept lateral forces. It is used with longitudinally constrained pipe runs to prevent buckling.

A guide can be either fixed or movable in the axial direction, for different applications. A pipe may slide in a clamp as a substitute for a proper pipe guide, sliding along the mounting plane, but this is permissible only when the pipe clamp contains an appropriate sliding sleeve.

Versions of pipe guide clamp

Form A: Version with movable guide shoe that allows axial pipe movement. Used e.g. close to expansion joints or after an anchor before an expansion loop.

Form B: Version mounted on a support structure. Used e.g. in pipe runs constrained with anchors at both ends. No axial pipe movement is possible.

Form C: Guide clamp in a vertical pipe run. This is to be installed so that pipe movement is possible in the axial direction, but the pipe is constrained radially.

Pipe clamps supporting vertical pipe runs

When the weight of a vertical pipeline is to be carried by fastenings, then a support ring is needed on the pipe to transfer the load. This type of pipe attachment is called a vertical stop. The load is much higher than for a sliding or guiding clamp on a horizontal pipe run. Caution: the clamp support plate must be attached sufficiently solidly with screws or pegs.

Pipe hangers

A pipe hanger or pendulum-type pipe clamp can, like a sliding pipe clamp, only accept vertical load. These are mostly used for attachment to a ceiling or ceiling beam/framing. There are single and double hanger versions. The pipeline is vulnerable to vibration when attached, and normally requires intermediate supports to stabilize it.

Attachments for valves

Attachments for valves have to accept loads from the weight of the valves and their contents. In addition, they should prevent that forces from operating the valve are transferred to the pipeline. In a well-designed fastening system, the valve can be replaced without disassembling the surrounding pipe. If the valve fastening also serves as an anchor, it must also withstand the effects of inhibiting length changes.

Anchors

Anchors are intended to restrict pipeline movement to a particular direction, or else prevent it altogether. Anchors also must accept reaction forces from expansion joints and socket joints. Anchors must be con-

structed that the magnitude and direction of system expansion and contraction can be assigned to existing compensating elements.

The pipeline is affixed to the anchor clamp by butt welding an appropriate fitting (e.g. a pipe ring) to the pipeline. In some cases to be considered individually, electro fusion sockets can be used in place of pipe rings. The diameter of the pipe rings should be chosen so that common pipe clamps can be used. When choosing a pipe clamp, be sure that it is stable and will not warp under torsion.

Squeezing a pipe in a pipe clamp as an alternative to pipe rings or electro fusion sockets is not permitted. Improper attachment methods frequently lead to deformation of the pipe cross section or pipe surface damage with notching. This can lead to premature pipeline failure. Only in exceptional cases should the pipe ring be connected to the pipe with hot gas welding. Take note that welding should always be done by a trained or certified welder.

It is not permitted to weld axial braces to the pipe to support the radial pipe ring, because it causes high point loads and therefore stress concentration.

Installations systems and standardized mounting elements

The commercially available installation systems (rail with accessories) are a great help in mounting plastic pipelines. When choosing a rail profile, it is important to check the vertical load that can be accepted by the installation track. This depends on the span between rail supports.

Often the manufacturer's technical specifications state an permissible span that would result in unacceptable pipe sagging. Using the installation systems

requires a calculation to determine the deformation. This is possible to some degree with the manufacturer's diagrams.

The permissible deformation for the pipeline is about $f = L/750$ to $L/500$, with L being the support interval for the pipeline. The installation track frequently has a different deformation behaviour from the pipeline, as a result of the point load on the track.

Difficulties arise when horizontal loads must be transferred to the installation track, e.g. anchor forces. Manufacturer's technical documentation gives no information on this subject, so usually additional calculations are needed. This is also true for attachment elements such as tie bars, wall brackets, and similar elements.

Note: Users are advised at the project planning stage to work thoroughly through the application possibilities and limits, and the layout of their installation system. The general guidelines for designing a mounting system for thermoplastic pipelines are contained in Guideline DVS 2210-1.

5.3.2 Determining of length changes

Length changes from temperature variation

Temperature dependent length changes in thermoplastic pipelines is given by:

$$\Delta L_T = \alpha \cdot L \cdot \Delta v$$

where:

- ΔL_T = temperature dependent length change [mm]
- α = linear expansion coefficient [mm/m · K, or 1/K]
- L = pipe length [m, or mm]
- Δv = temperature difference ($\Delta T = T_{max} - T_{min}$) [K]

The linear thermal expansion coefficients^① α for the preceding equation are as follows:

Table 6: Average α values

Material	mm/(m · K)	1/K
PE	0.18	$1.8 \cdot 10^{-4}$
PP	0.16	$1.6 \cdot 10^{-4}$
PVDF	0.13	$1.3 \cdot 10^{-4}$
E-CTFE	0.05	$0.5 \cdot 10^{-4}$

① The temperature dependence of the expansion coefficients can be neglected when determining length changes in a pipeline.

Length changes with internal overpressure

Length changes do not only result from temperature variation, but also from internal overpressure loads. The expansion of a closed and frictionless mounted pipeline from internal overpressure is:

$$\Delta L_p = \frac{0.1 \cdot p_o \cdot (1 - 2\mu)}{E_c \cdot [(d_e/d_i)^2 - 1]} \cdot L$$

where:

- ΔL_p = internal overpressure-dependent length change [mm]
- L = total pipe run length [mm]
- p_o = internal overpressure [bar]
- μ = Poisson's ratio = 0.38 for thermoplastics [-]
- E_c = creep/elasticity modulus^② [N/mm²]
- d_e = external pipe diameter [mm]
- d_i = internal pipe diameter [mm]

② The modulus to be used in the equation is chosen according to each individual case. For loads of short duration e.g. overpressure testing, E_{st} is appropriate, for loads of long duration, the time-dependent creep modulus E_{ct} is required.

Length changes from effects of transported material

Some transported materials e.g. solvents swell plastic pipes. This brings noticeable volume increase in longitudinal and axial directions: the pipe run becomes longer and the pipe diameter larger. In the mid and long term, pipe material strength and elastic modulus decreases.

To assure undisturbed transport of solvents, these swelling effects should be considered, especially in the planning phase.

5.3.3 Pipe components to take up length changes (expansion bends)

Plastic pipelines are laid in the main way as metal ones. Real differences stem from the higher thermal expansion coefficients of plastics, and the noticeable changes in pipeline lengths associated with temperature variation. The original temperature is not significant. Changes in length can be both in positive and negative direction.

- Positive direction: Operating pipe wall temperature higher than original temperature
Result: pipe run becomes longer
- ← Negative direction: Operating pipe wall temperature lower than original temperature
Result: pipe run becomes shorter

The original temperature may be set as either the installation temperature or the minimal operating temperature. As default when nothing is known, $T_M = 15^\circ\text{C} - 20^\circ\text{C}$ may be used for calculation.

A characteristic of proper plastic pipe laying is to put in bent pipe sections to take up the length change. These bent sections have usually 90° bends, including the connecting piece to the normal pipe. The literature frequently mentions expansion legs. The load on these expansion legs is important.

These bent sections are called in the following expansion bends. The different shapes may be distinguished by the name of the letter they resemble:

- L: change of direction
- Z: offset
- U: U loop (expansion loop)
- R: a 3-dimensional system

The R loop has an additional spatial dimension as compared to the other three (flat) types.

It is also common to speak of:

Expansion in 2 dimensions → planar expansion bends

Expansion in 3 dimensions → spatial expansion bends

The following section discusses dimensioning planar expansion bends. Diagrams based on extensive calculations have been produced in order to simplify dimensioning. The many calculated results that went to make up the SIMONA diagrams assure that stresses obtained using the diagrams will be in the permissible range.

Examples are worked out, and will demonstrate how to use the diagrams for determining expansion bends. Results obtained with the diagrams have already taken into account the allowable overpressure for the straight pipe in the various cases, as given in the following diagrams.

Note that the longitudinal bending stresses in the expansion bends are present for a limited time only, i. e. when the temperature changes. If a steady operating state is then established, the stresses decrease by relaxation of the plastic. The nominal maximum stresses are therefore short-lived, and do not lead to pipe failure in the long term. It is more critical when temperature changes are ongoing or frequent.

Caution:

If expansion legs are made shorter than the dimensions determined with the SIMONA diagrams, repeated temperature changes can cause pipeline failure, either at the expansion bend or at a constraining point (anchor or pipe guide).

It is especially important not to exceed the fastening intervals given in sec. 5.3.5 in the vicinity of pipeline sections under bending stress.

Calculations for expansion bends

Calculating for expansion bends requires in most cases considerable effort and special knowledge of pipe static. The systematic of these calculations will not be discussed in detail here.

However, it is often possible to determine the main dimensions of an expansion bend with simple relationships that give a result on the safe side. For an L expansion bend, the following is sufficiently accurate for dimensioning:

$$L_B = \sqrt{\frac{3 \cdot d_e \cdot L_{1,2} \cdot \Delta T \cdot \alpha \cdot E_{cm}}{\text{per } \sigma_b}}$$

- where:
- L_B = required expansion bend leg length [mm]
 - d_e = pipe diameter, external [mm]
 - $L_{1,2}$ = system lengths determining expansion bend [mm]
 - ΔT = temperature difference [K]
 - α = coefficient of thermal expansion [1/K]
 - E_{cm} = creep modulus, average for nominal lifetime [N/mm²]
 - per σ_b = permissible bending stress component for the nominal lifetime [N/mm²]

The average creep modulus for the nominal lifetime can be determined using the SIMONA Diagrams of sec. 3. The procedure is:

$$E_{cm} = [0.5 \cdot (E_{(\min T_{op})} + E_{(\max T_{op})})] / A_2$$

Where:

- $E_{(\min T_{op})}$ = creep modulus at minimum operating temperature^① [N/mm²]
- $E_{(\max T_{op})}$ = creep modulus at maximum operating temperature [N/mm²]
- A_2 = reduction factor through transported substance [-]

① The installation temperature $T_m = 5$ to 20°C is normally used for the minimum operating temperature T_{\min} . Since the creep modulus for bending is temperature and stress dependent, it is recommended to set $E_{(\min T_{op})} = E_{LT(20^\circ\text{C})}$ from Table 1 (abstracted from Table 7, DVS 2205-2) when calculating the average creep modulus for bending.

Expansion leg creep modulus for 20 °C, lifetime 25 years

Material	$E_{LT(20^\circ\text{C})}$
PE 80, PE 100	235 N/mm ²
PP-H	330 N/mm ²
PP-R	276 N/mm ²
PVDF	720 N/mm ²

The permissible bending stress component for the nominal duration follows from using the equations in sec. 4:

$$\text{per } \sigma_b = [(\sigma_v \cdot f_s) / (A_2 \cdot A_4 \cdot SF) - \sigma_{(p)}]$$

The Z, U, and R expansion bends are not treated within standardized documentation because of the many different forms, measurements, and operating conditions and because the calculation procedure is somewhat involved.

SIMONA recommends choosing an appropriate calculation procedure whenever static calculations are required for plastic pipelines. This may be traditional (e.g. using DVS 2210-1, Supplement 1) or with a software program. We are happy to assist with obtaining a static calculation, or refer you to engineering consultants who specialize in this field.

Note: The use of SIMONA diagrams to dimension expansion bends does not replace a static calculation in the limiting cases.

Application of SIMONA diagrams for determination of expansion bend leg lengths

SIMONA diagrams are not suitable for optimising expansion leg dimensions. They are only to assure that bending stresses created by length changes in the pipeline section nearby do not exceed allowable limits. Besides determining the expansion legs, one must also investigate the allowable operating overpressure in the straight pipe runs. The procedure is explained in the example see section 10 Explanations [5].

Dimensioning a change of direction (L expansion bend)

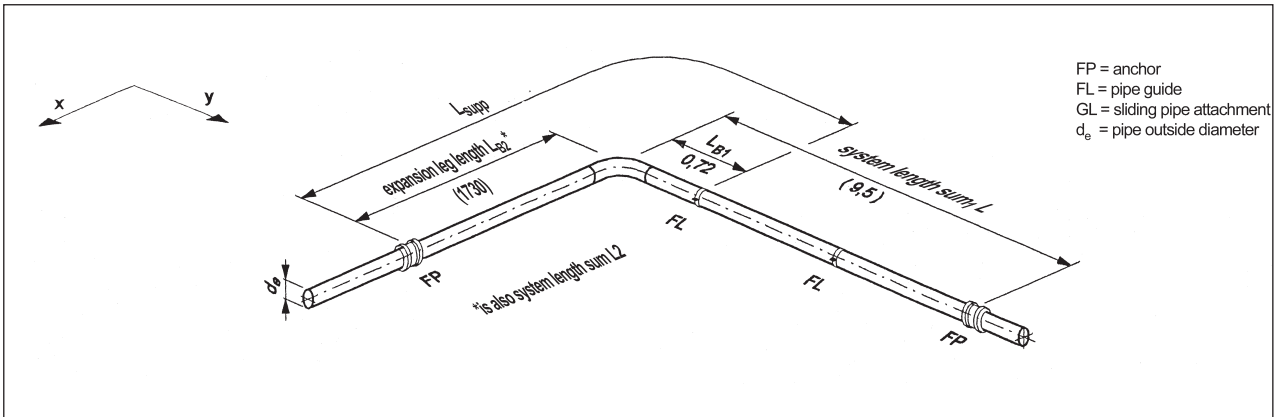

For the dimensioning of L expansion bends using the SIMONA diagrams please proceed as follows:

Diagram:

System measurement L expansion bend PE 80 (see diagram p. 61)

Given: PE 80 pipeline

Pipe diameter: $d_e = 280$ mm

Nominal pressure/SDR class:

The diagram can be used for all PE pipelines, independent of nominal pressure and SDR class.

Verification of permissible overpressure should be done as in the Expl. 10 [5].

Minimum operating temperature: $\min T_o = 20^\circ\text{C}$

Maximum operating temperature: $\max T_o = 40^\circ\text{C}$

Installation temperature:

Installation temperature is usually between 5°C and 25°C . At pipeline commissioning, there is a one-time temperature change. The base for temperature difference is therefore not the installation temperature, but rather the difference between minimum and maximum operating temperatures must be considered for expansion.

Temperature difference: $\Delta T = 40 - 20 = 20$ K

System length for expansion bend: $\text{sum } L_1 = 9,500$ mm

Required expansion bend legs:

req $L_{B2} = 1.730$ mm is the expansion leg corresponding to the system length L_2 (from diagram). The system length L_2 is = req $L_{B2} = 1.730$ mm. Obtaining the L_{B1} expansion leg from the diagram by the same procedure gives req $L_{B1} = 720$ mm as the minimum distance of the guide pipe clamp from the elbow.

System Measurements: L Expansion Bend
Material: PE 80

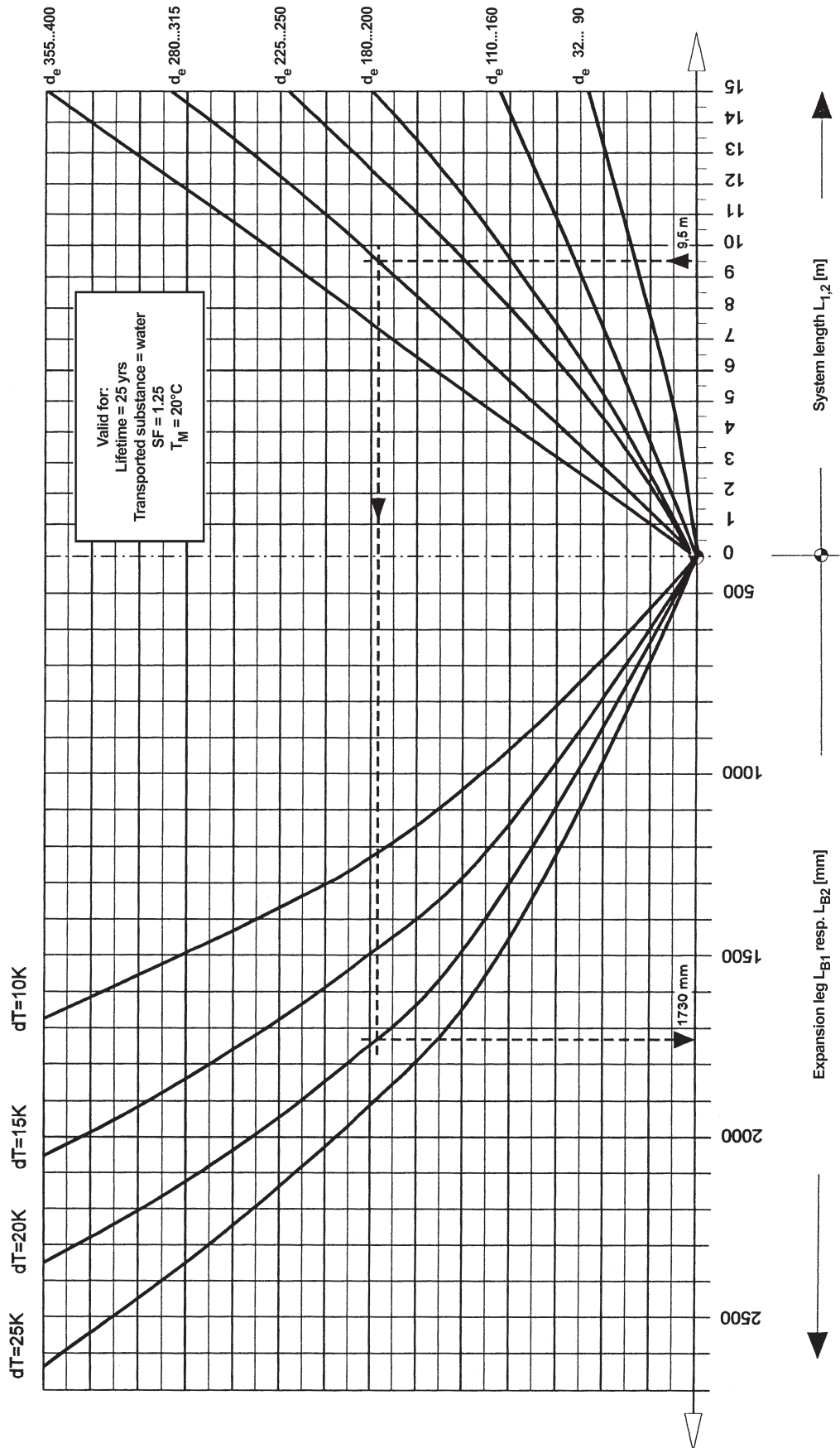

System Measurements: L Expansion Bend
Material: PE 100

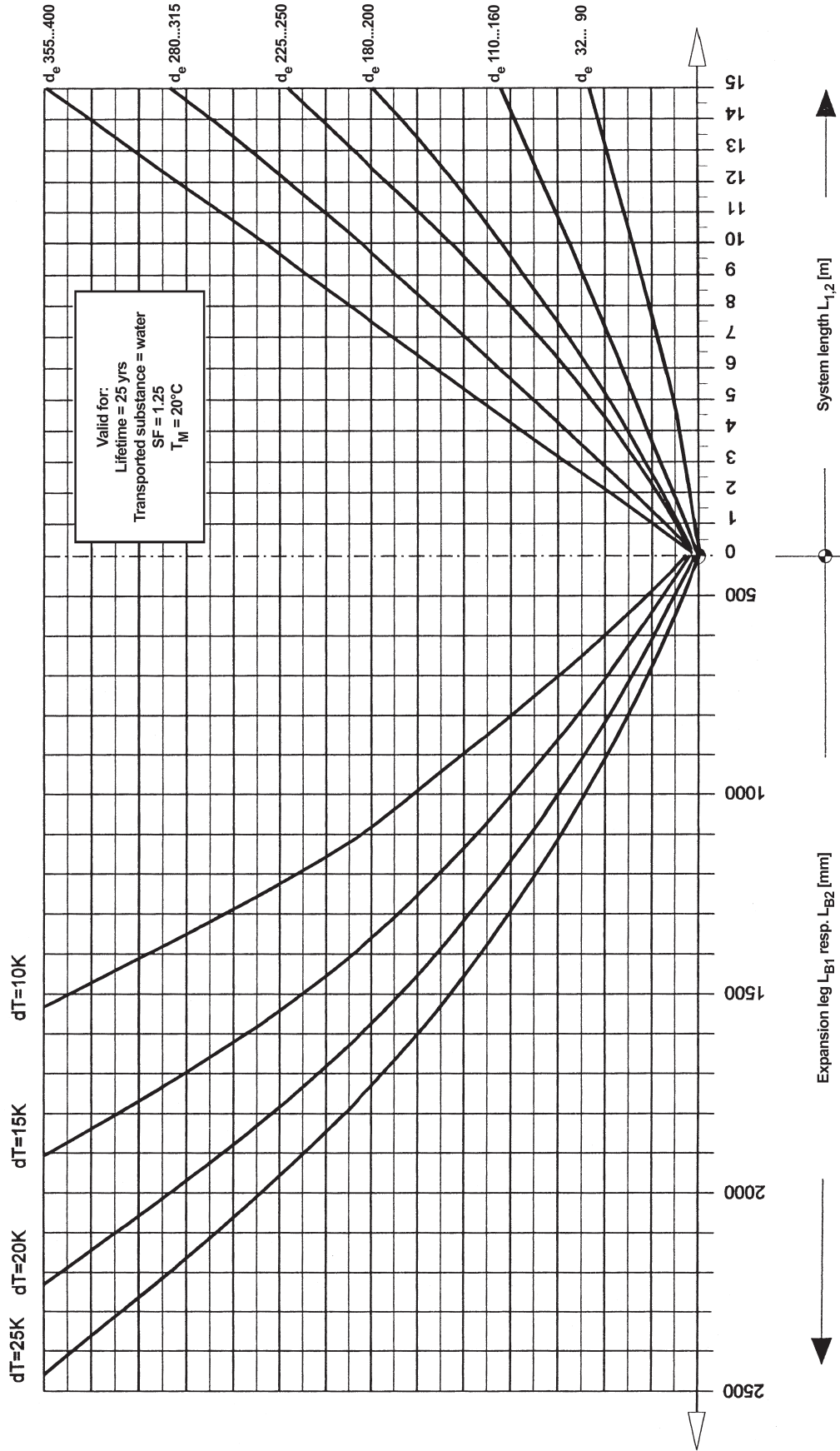

System Measurements: L Expansion Bend
Material: PP-H

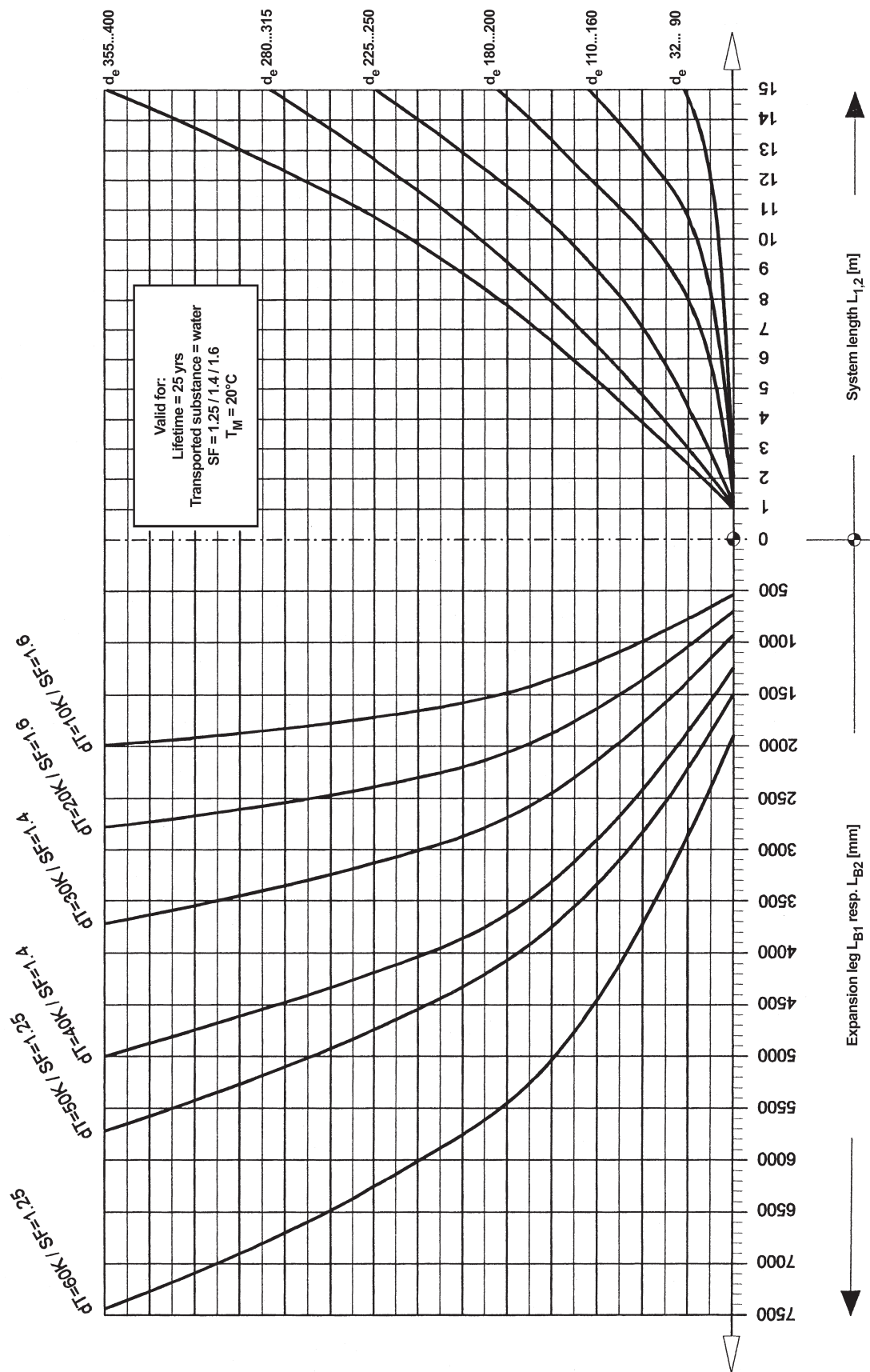

System Measurements: L Expansion Bend
Material: PP-R

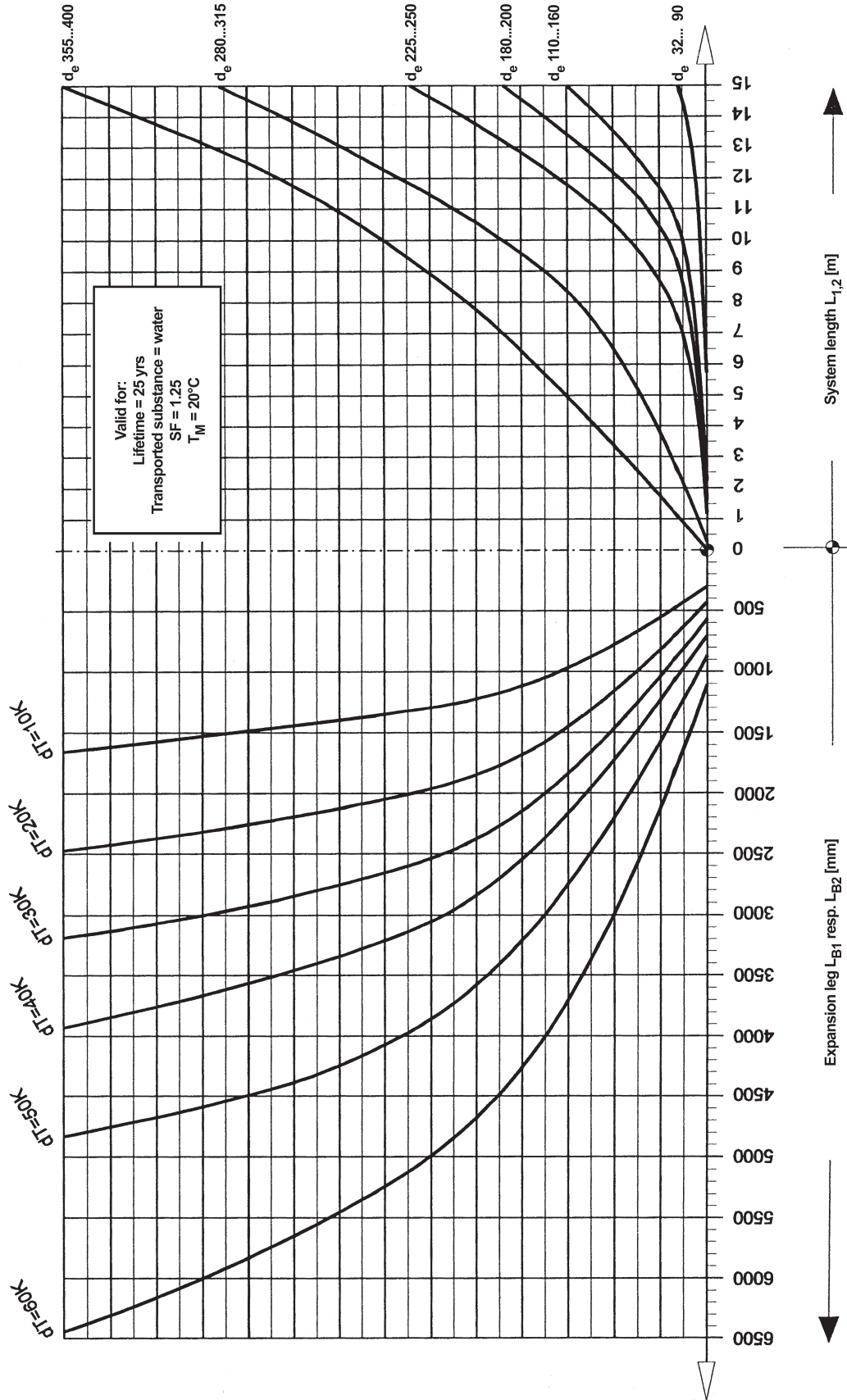

System Measurements: L Expansion Bend
Material: PVDF (d_e 16 to 32)

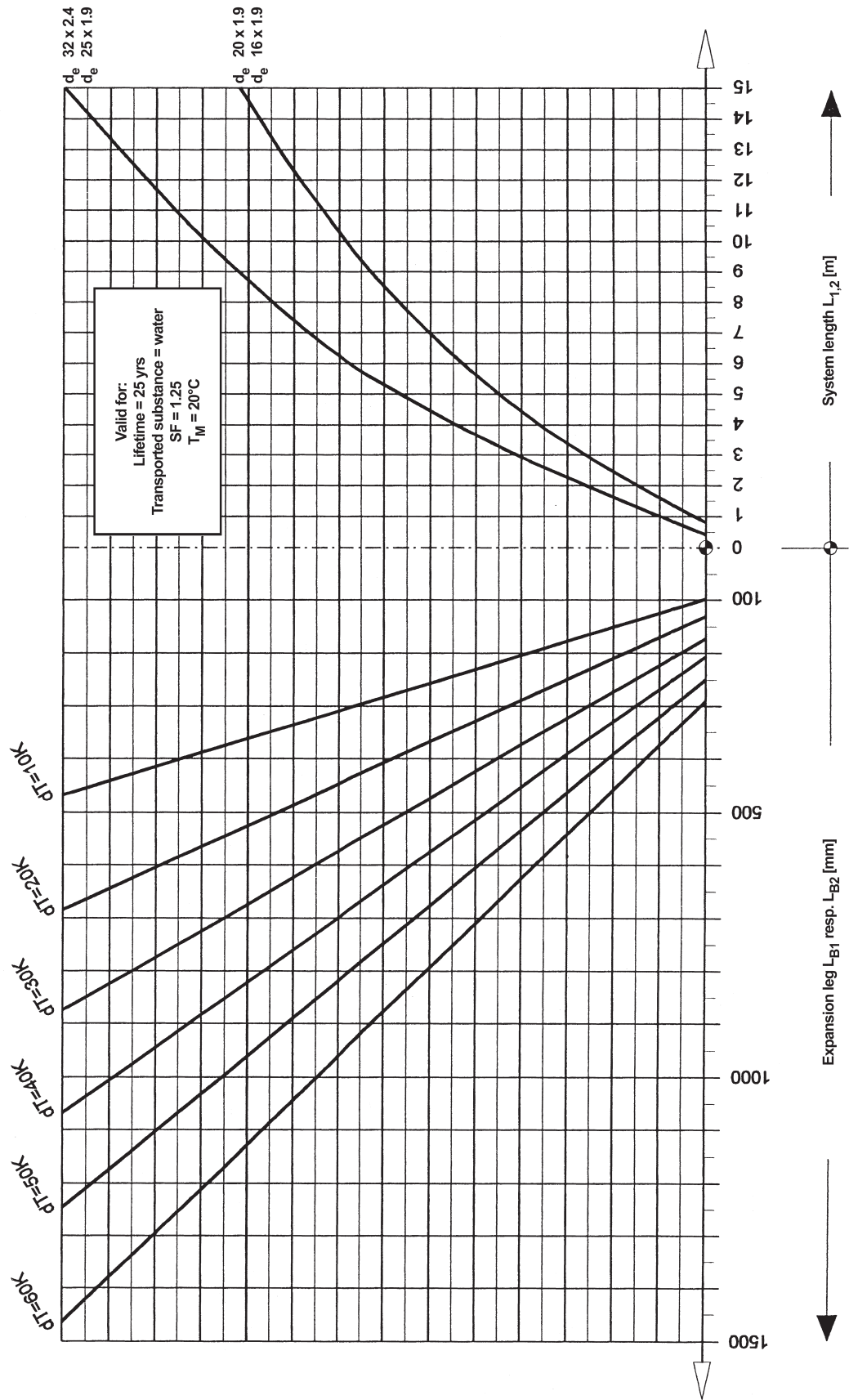

System Measurements: L Expansion Bend
Material: PVDF (d_e 40 to 110)

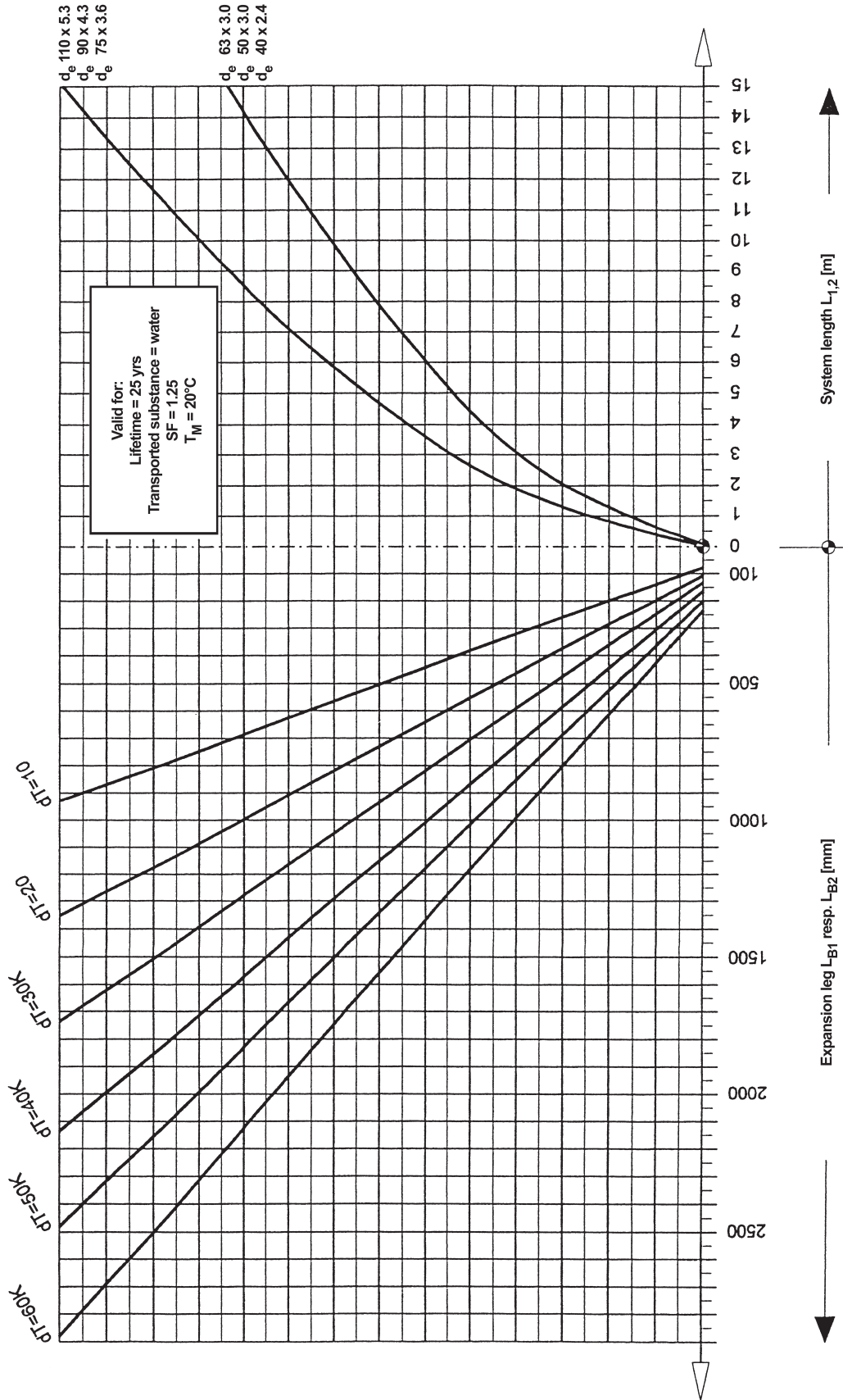

System Measurements: L Expansion Bend
Material: PVDF (d_e 125 to 225)

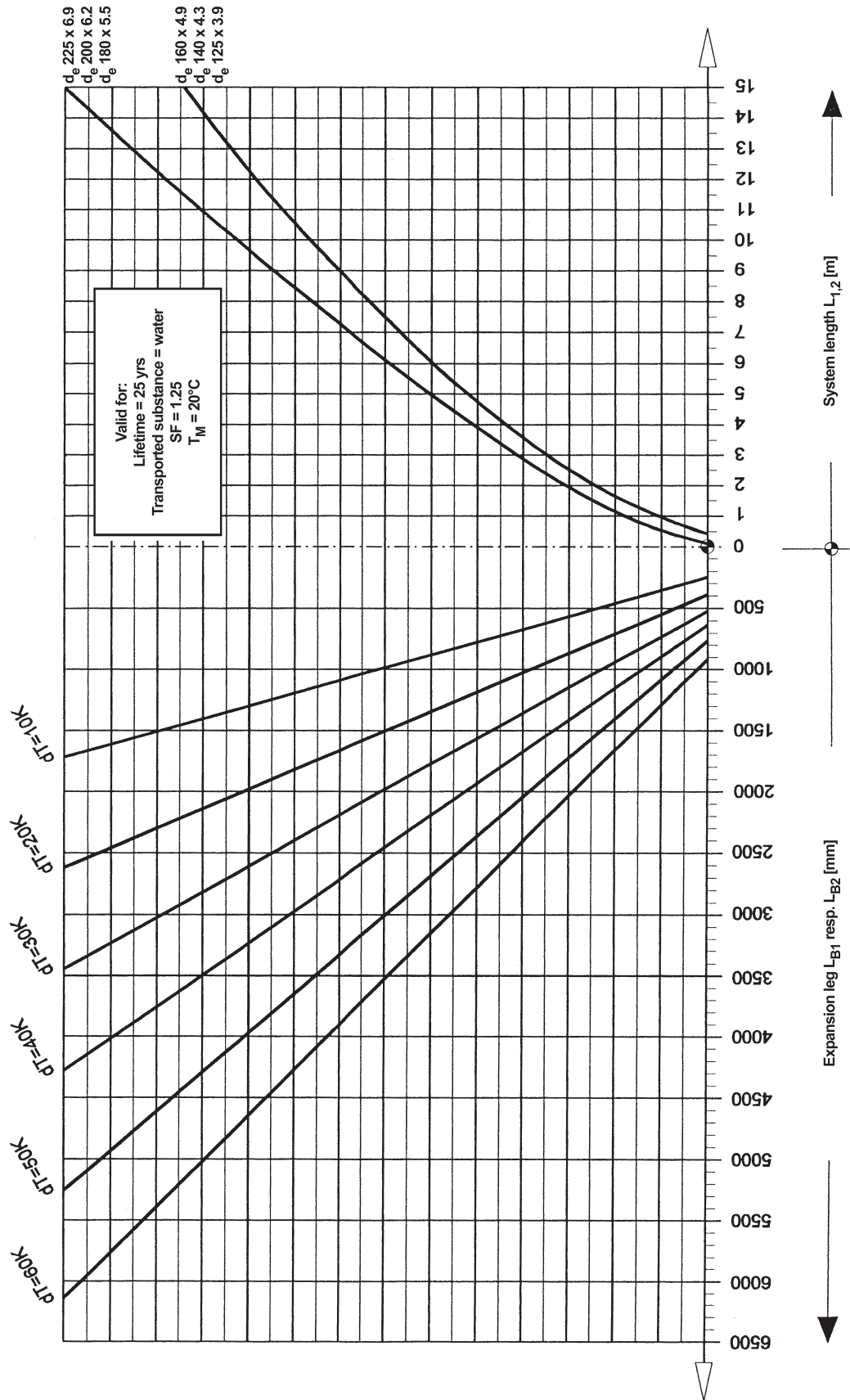

Dimensioning an offset (Z-loop)

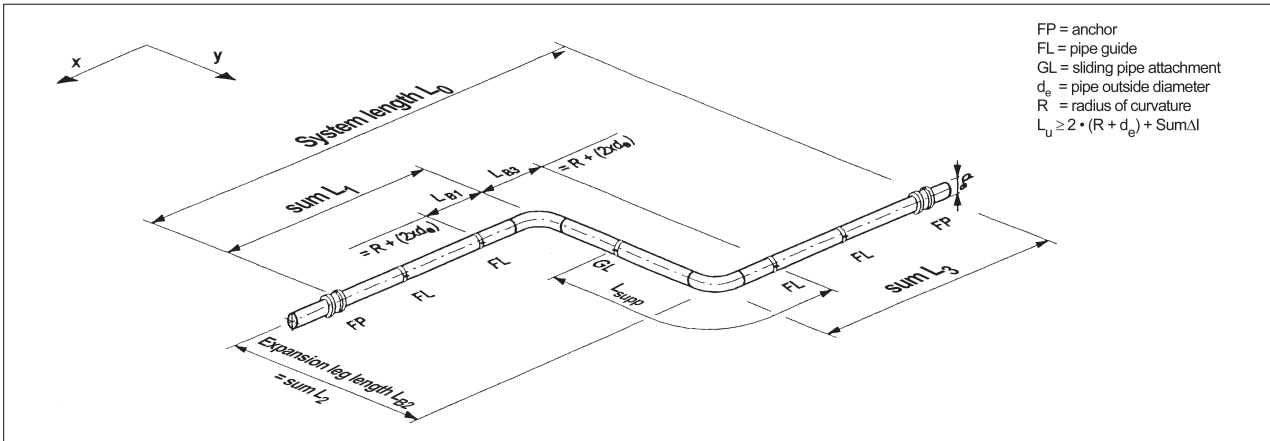

Offsets are very similar to changes in direction. As the figure indicates, a Z-loop can take up length changes from both directions, so it is more elastic than a change of direction. This elasticity means that in the active area of the expansion bend, pipe guides (FL) and other mounting elements restraining horizontal movement must not be used, but rather sliding pipe attachments (GL) which preserve elasticity.

The elasticity of the offset depends on the expansion leg length L_{B2} within the system. The more the symmetry of the system is reduced from $sys L_1 \neq sys L_3$, the more the expansion bend loses elasticity.

The limit of an offset ($sys L_1 = 0, sys L_3 = sys L_0$) is a change of direction (L bend). For all cases where the expansion leg $sys L_{B2}$ cannot be placed symmetrically, the solution can be taken from the second following example.

The following example shows how to dimension a Z-loop using the SIMONA Diagrams.

Given: PE 80 pipeline

Pipe material: No distinction is made between PE 80 and PE 100 when dimensioning an offset with the SIMONA Diagram.

Pipe diameter: $d_e = 280 \text{ mm}$

Nominal pressure/SDR class: The diagram can be used for all PE pipelines, independent of nominal pressure and SDR class. Verification of permissible overpressure should be done as in the Expl. 10 [5].

Minimum operating temperature: $\min T_o = 20^\circ\text{C}$

Maximum operating temperature: $\max T_o = 40^\circ\text{C}$

Installation temperature: Installation temperature is usually between 5°C and 25°C . At pipeline commissioning, there is a one-time temperature change. The base for temperature difference is therefore not the installation temperature, but rather the difference between minimum and maximum operating temperatures must be considered for expansion.

Temperature difference during operation:

$$\Delta v = \Delta T = 40 - 20 = 20 \text{ K}$$

System length for Z expansion bend:

$sys L_0 = 17 \text{ m}$, symmetric legs

Required expansion bend legs:

req L_{B2} : For sys L_0 the diagram gives a minimum bend leg of 850 mm. req $L_{B1} = \text{req } L_{B3}$: For sys L_2 these are determined by the requirement of being no less than $2 \cdot d_e = 560$ mm. With this distance of the nearest pipe guide to the respective bend, the bending stresses will be in the permissible range.

Special case: Asymmetric offset

System length of offset: sys $L_0 = 17$ m

System leg length: sys $L_1 = 12$ m

Required expansion bend leg lengths:

req L_{B2} : For sys L_1 the SIMONA Diagram gives a minimum expansion leg for a change of direction of 1,200 mm. For req $L_{B1} = \text{req } L_{B3}$, the same value is used, $2 \cdot d_e = 560$ mm.

System Measurements: Z Expansion Bend
Material: PE 80 / PE 100

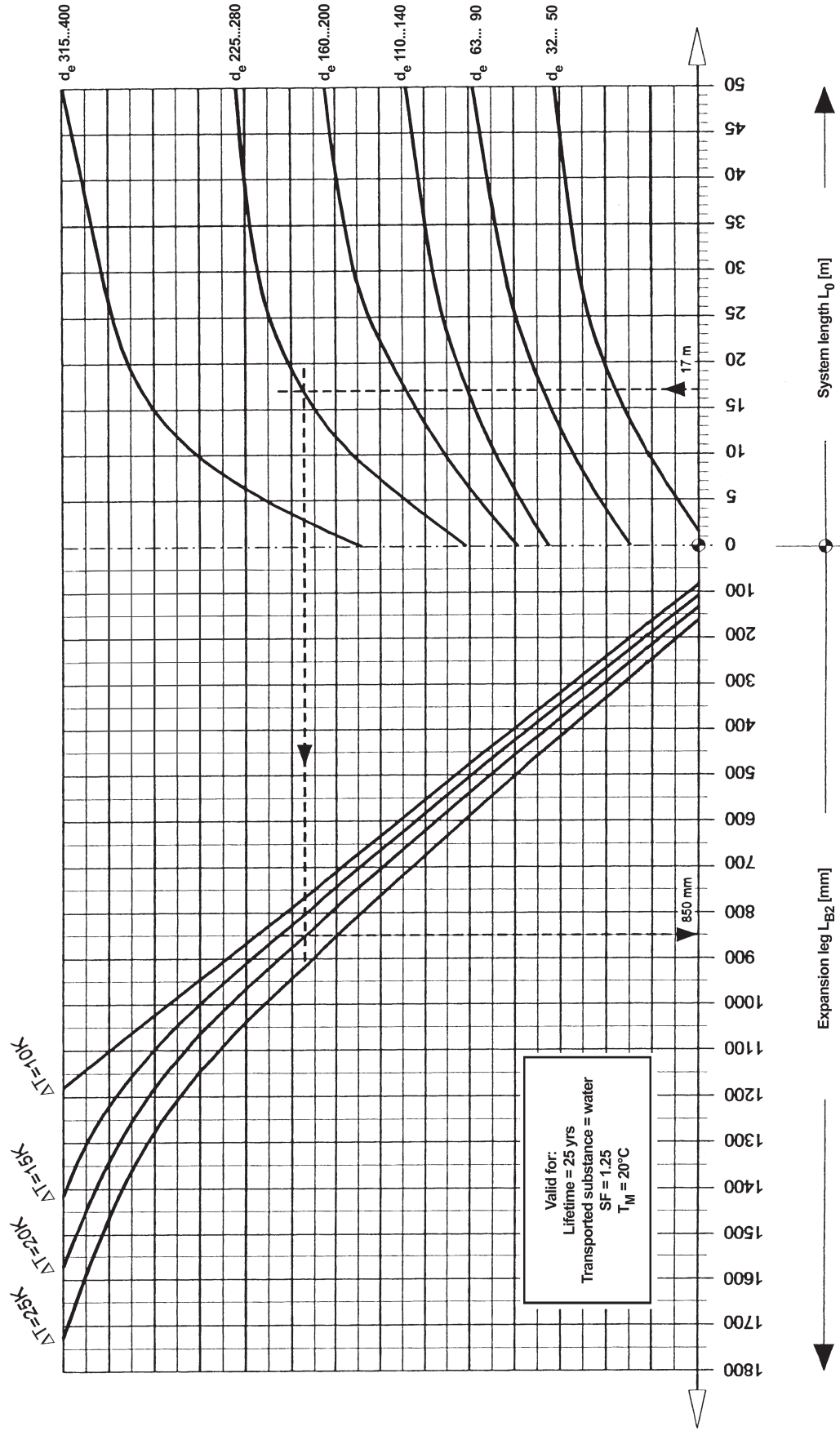

System Measurements: Z Expansion Bend
Material: PP-H / PP-R

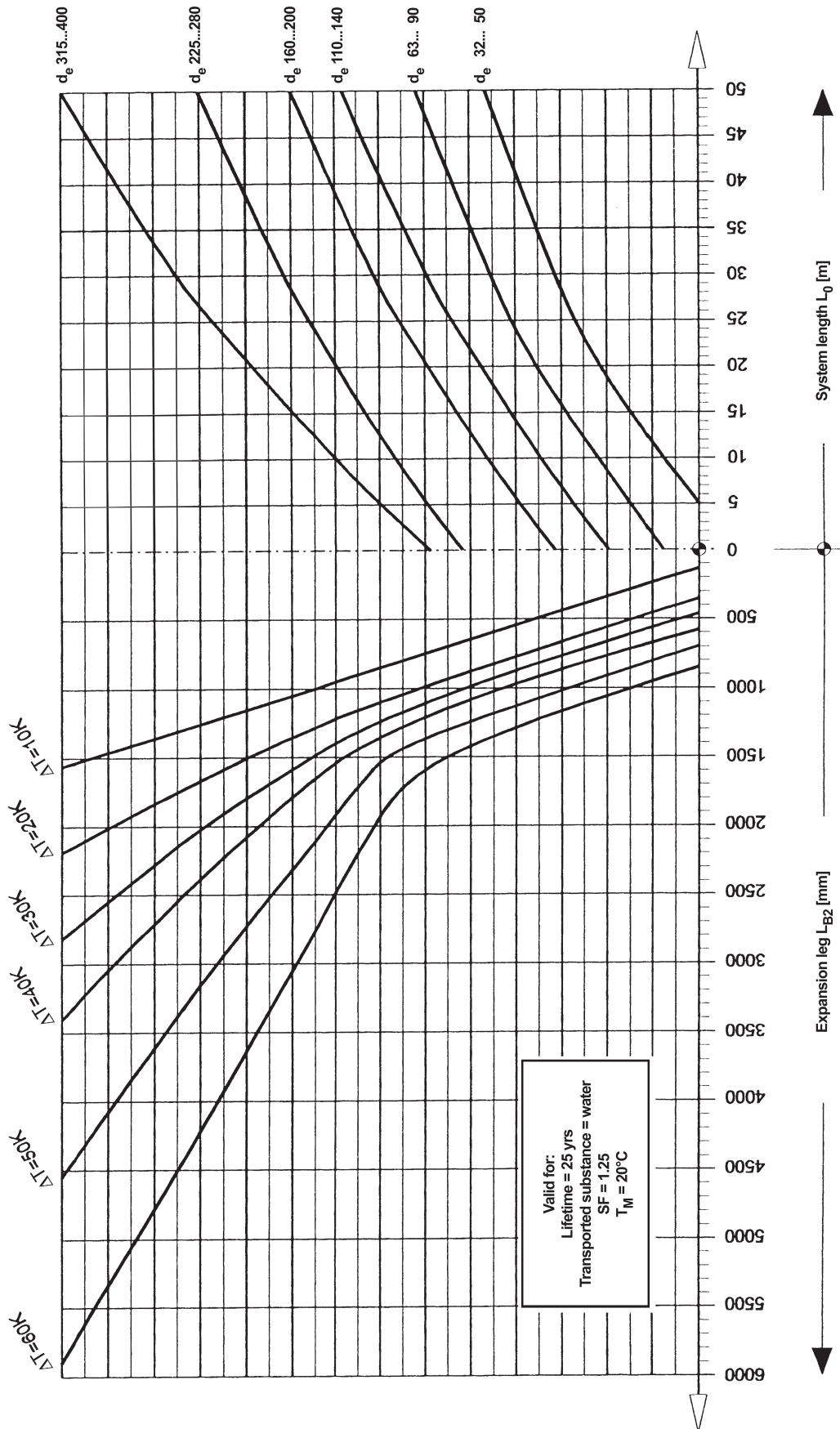

System Measurements: Z Expansion Bend
Material: PVDF (d_e 16 to 32)

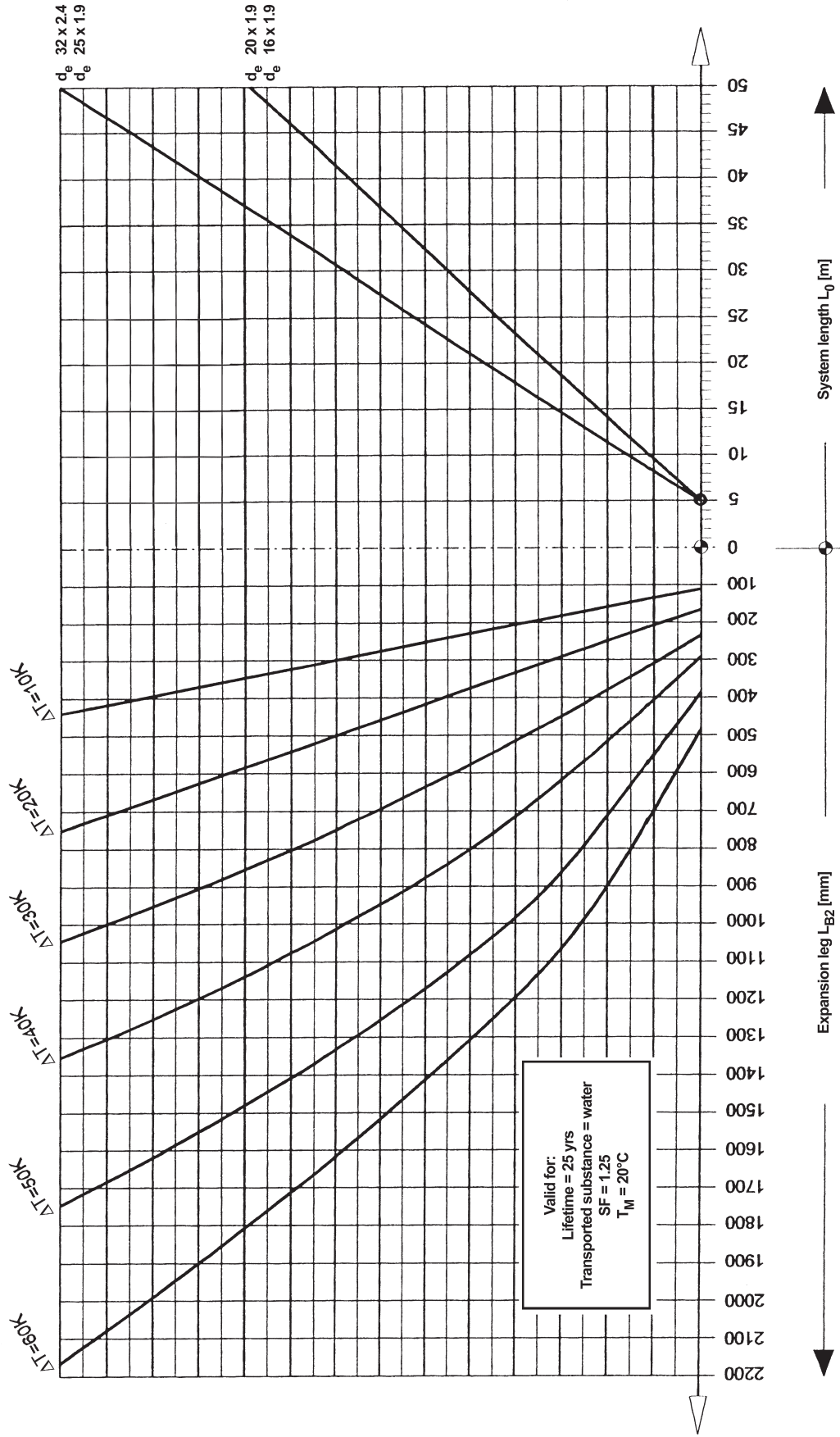

System Measurements: Z Expansion Bend
Material: PVDF (d_e 40 to 110)

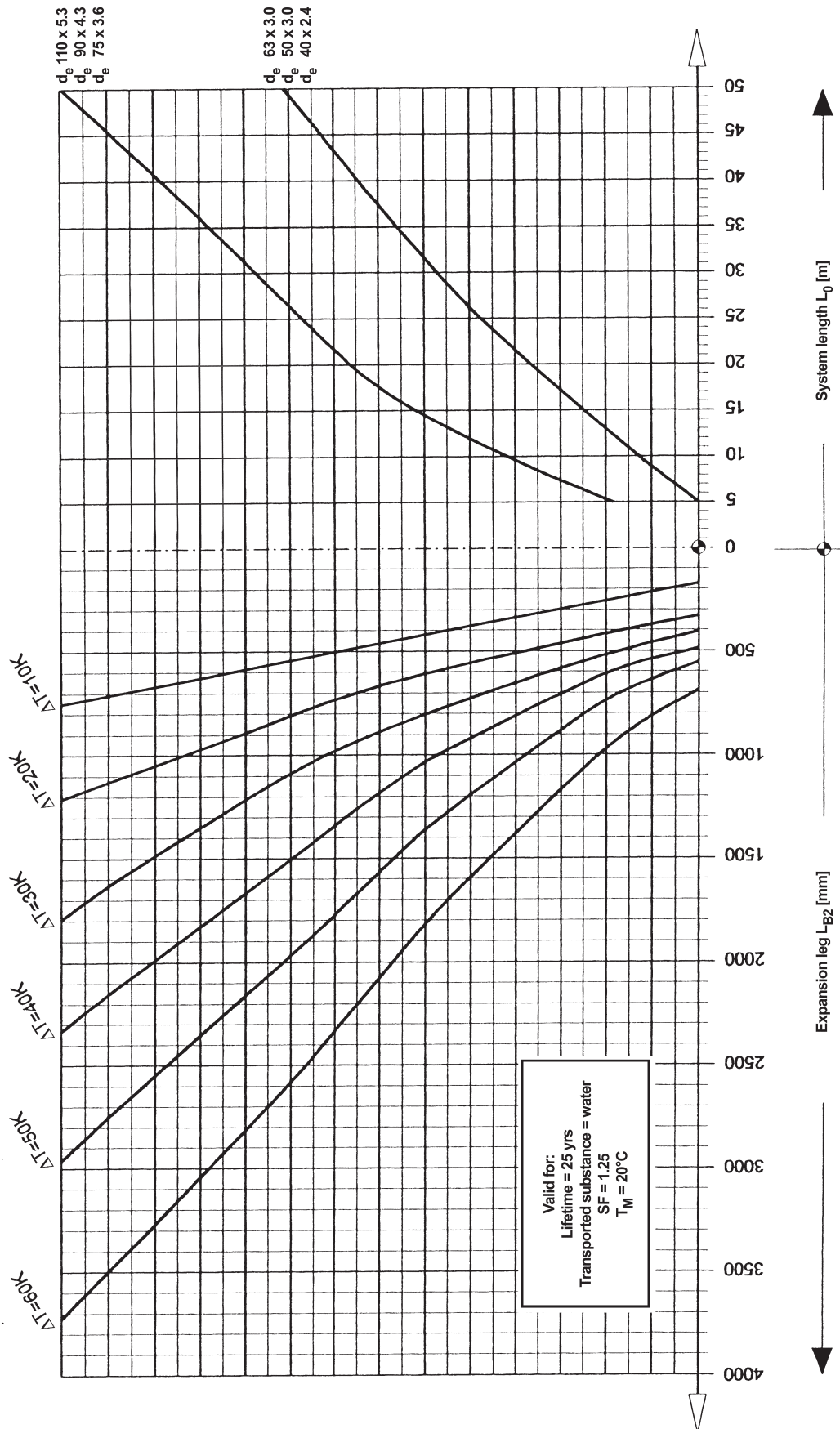

System Measurements: Z Expansion Bend
Material: PVDF (d_e 125 to 225)

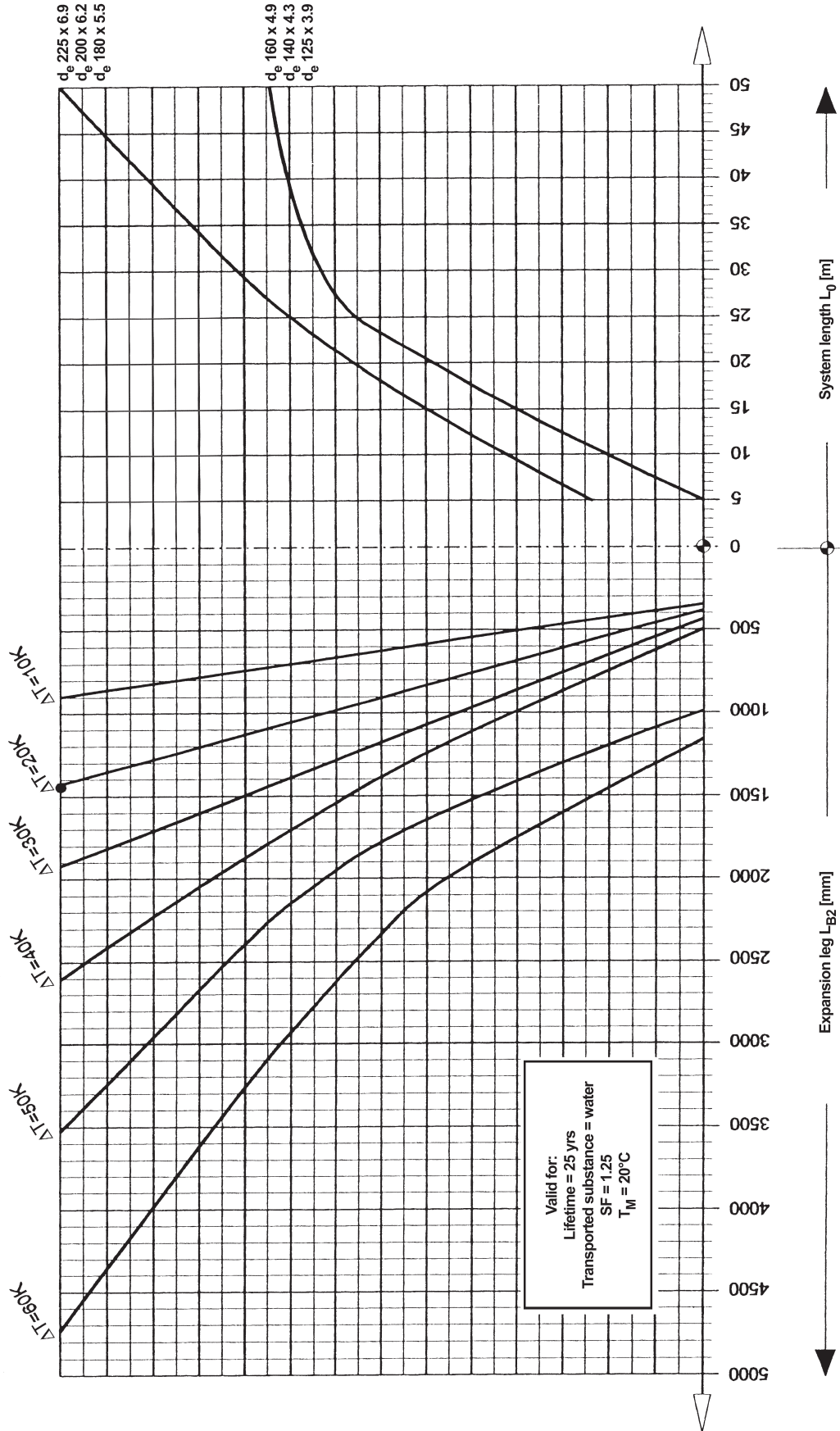

Dimensioning a U-loop

U-loops are used to take up expansion and contraction in long pipe runs. The figure indicates the system dimensions. It is important to provide adequate support for the U-loop. For proper functioning, only sliding pipe fastening should be employed around the expansion legs, not fixed pipe guides.

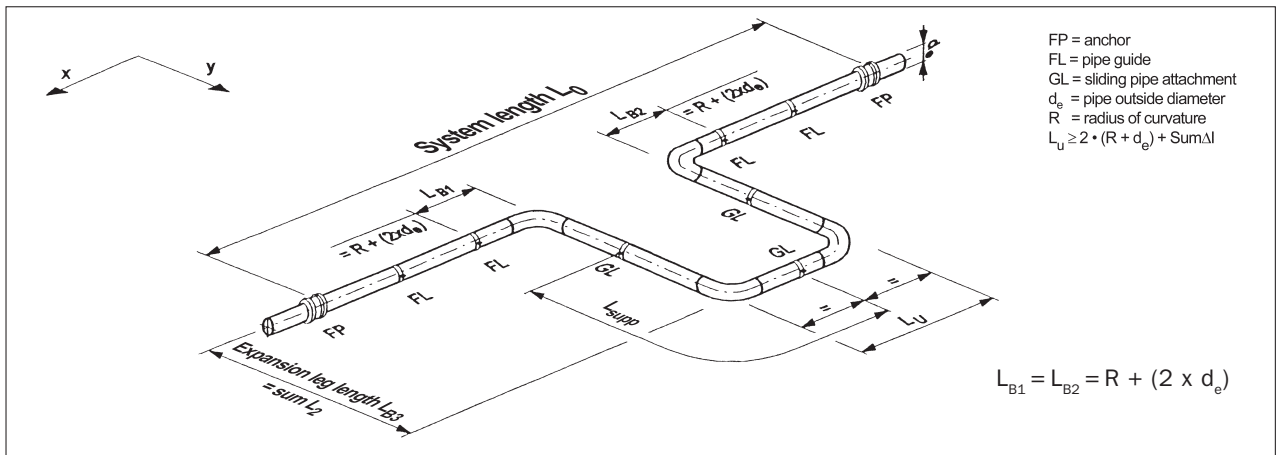

The following example shows how to dimension a U-loop using the SIMONA diagrams.

Given: PE 80 pipeline

Pipe material: No distinction is made between PE 80 and PE 100 when dimensioning a U-loop with the SIMONA Diagram.

Pipe diameter: $d_e = 280$ mm

Radius of curvature of bends: $R = d_e = 280$ mm

Nominal pressure/SDR class: The diagram can be used for all PE pipelines, independent of nominal pressure and SDR class. Verification of permissible overpressure should be done as in the Expl. 10 [5].

Minimum operating temperature: $\min T_o = 20^\circ\text{C}$

Maximum operating temperature: $\max T_o = 40^\circ\text{C}$

Installation temperature: Installation temperature is usually between 5°C and 25°C . At pipeline commissioning, there is a one-time temperature change. The base for temperature difference is therefore not the installation temperature, but rather the difference between minimum and maximum operating temperatures must be considered for expansion. For this example, installation temperature will be set at $T_M = 10^\circ\text{C}$.

Temperature difference during operation:

$$\Delta T = 40 - 20 = 20 \text{ K}$$

To be certain that the L_{B3} expansion legs do not touch at maximum temperature, the maximum temperature should be used to determine L_U .

Maximum temperature difference:

$$\Delta v = \max \Delta T = 40 - 10 = 30 \text{ K}$$

U-loop system length: $\text{sys } L_o = 43$ m

Length change calculation:

$$\Delta l_T = \alpha \cdot \text{sys } L_o \cdot \Delta T = 0.00018 \cdot 43 \cdot 1.000 \cdot 30 = 232 \text{ mm (see also sec. 5.3.2)}$$

Required expansion leg length:

$$\text{req } L_{B1} = \text{req } L_{B2} = 280 + 2 \cdot 280 = 840 \text{ mm}$$

$\text{req } L_{B3}$: For $\text{sys } L_o$ the diagram for U-loops from PE 80/PE 100 gives $1.450 \text{ mm}^{\text{®}}$.

$$\text{req } L_U = 2 \cdot (280 + 280) + 232 = 1.352 \text{ mm.}$$

® The minimum expansion leg length in the diagrams takes into account that friction with the pipe supports can prevent the full length change.

System Measurements: U Expansion Bend
Material: PE 80 / PE 100

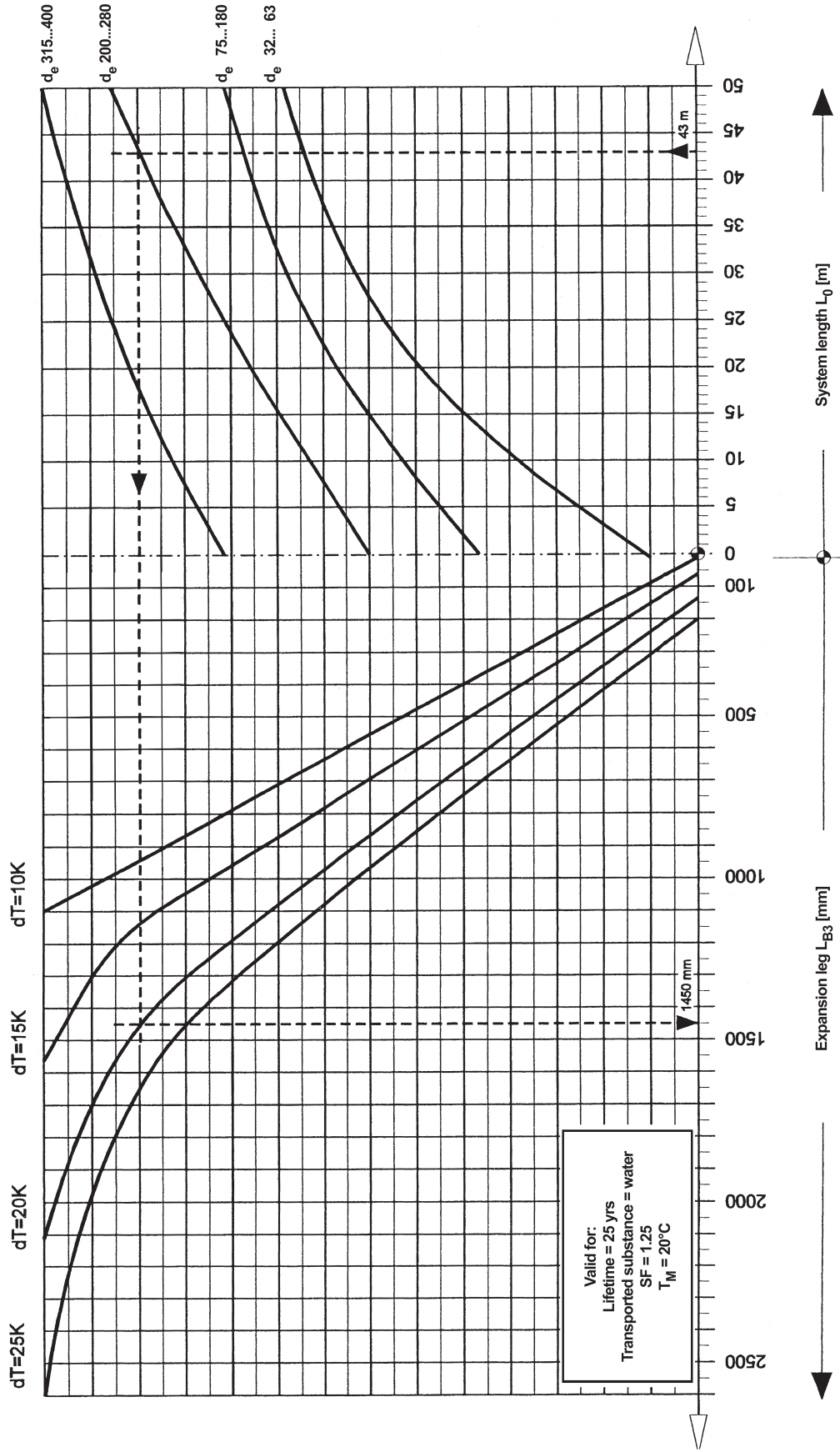

System Measurements: U Expansion Bend
Material: PP-H/PP-R

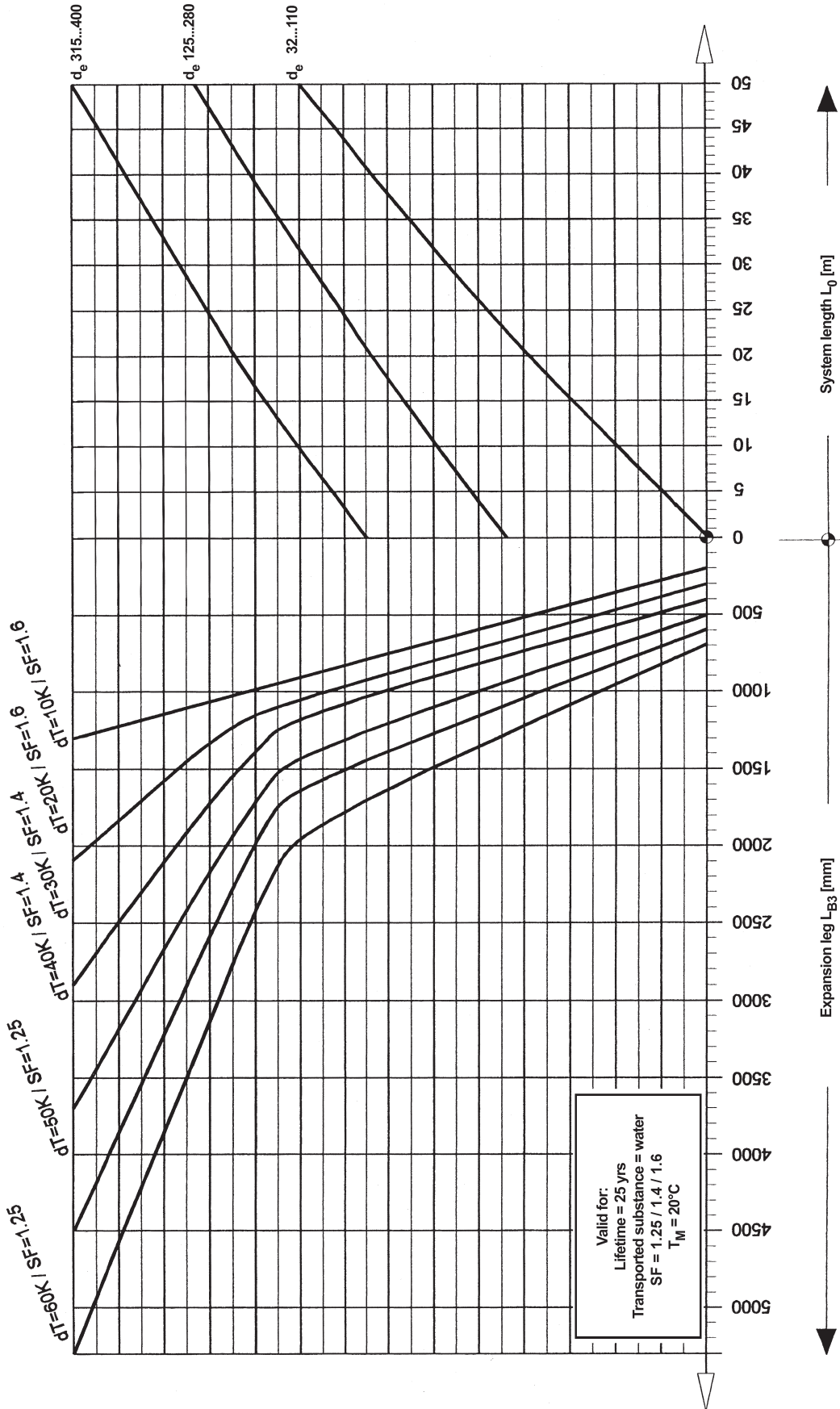

System Measurements: U Expansion Bend
Material: PVDF (d_e 16 to 32)

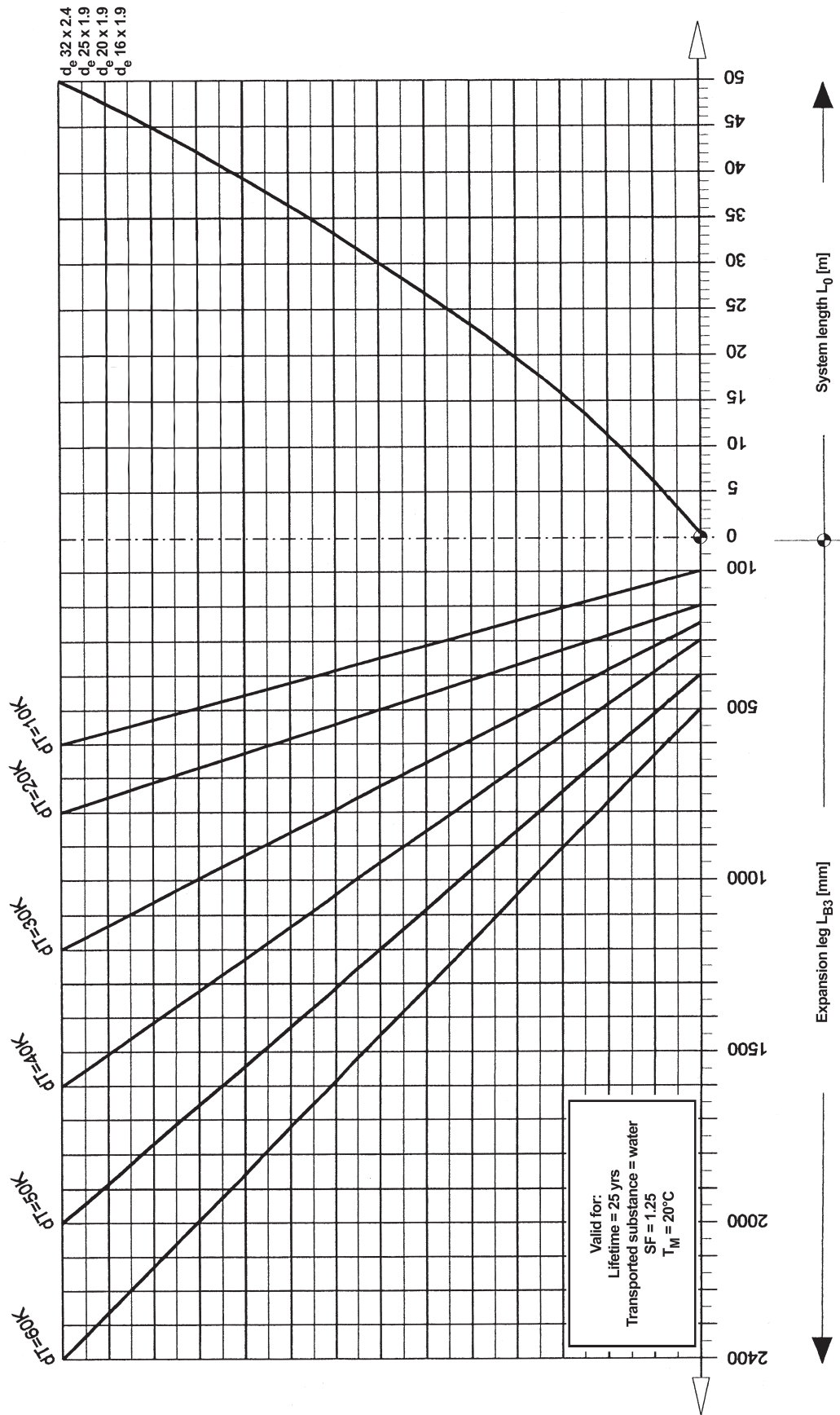

System Measurements: U Expansion Bend
Material: PVDF (d_e 40 to 110)

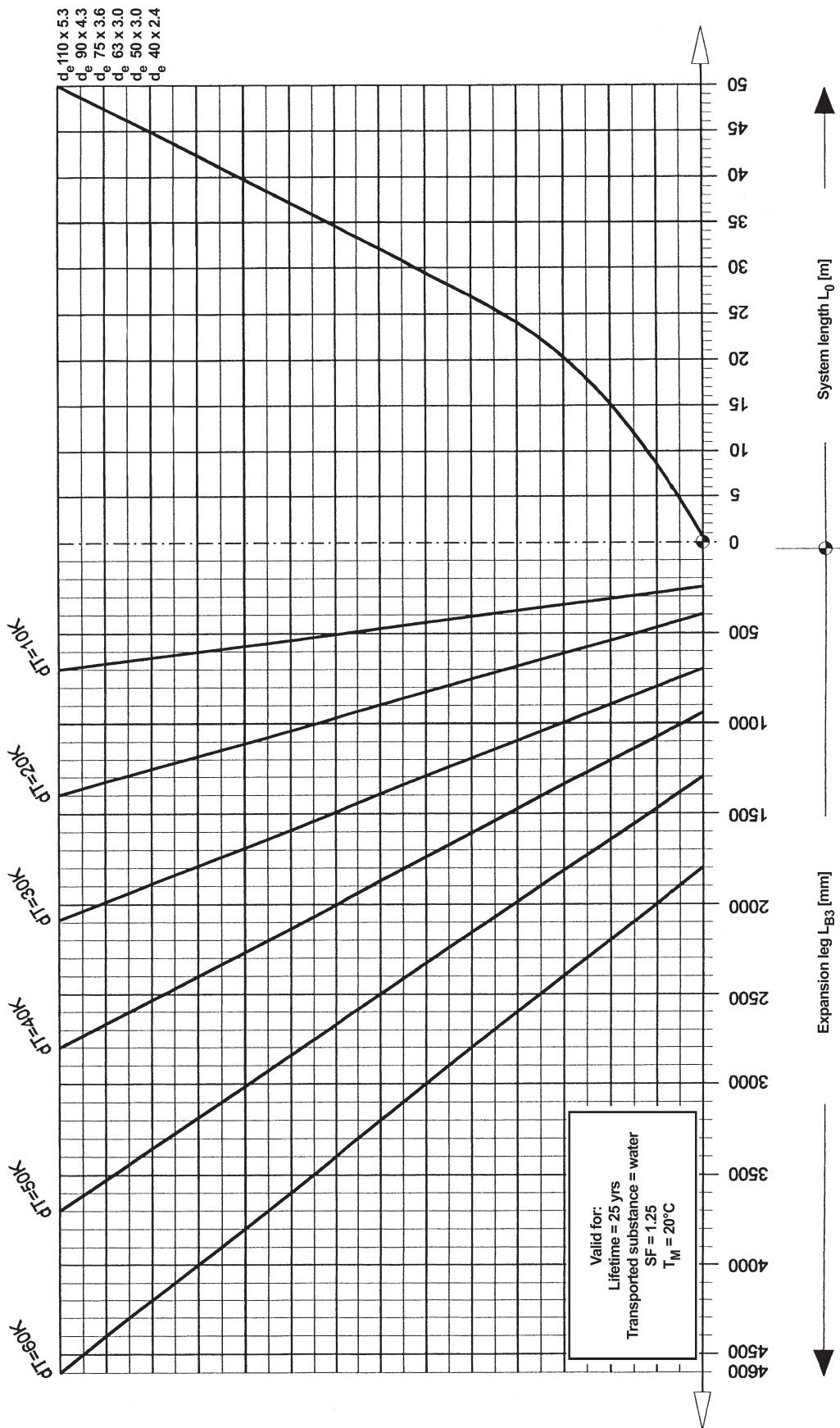

System Measurements: U Expansion Bend
Material: PVDF (d_e 125 to 225)

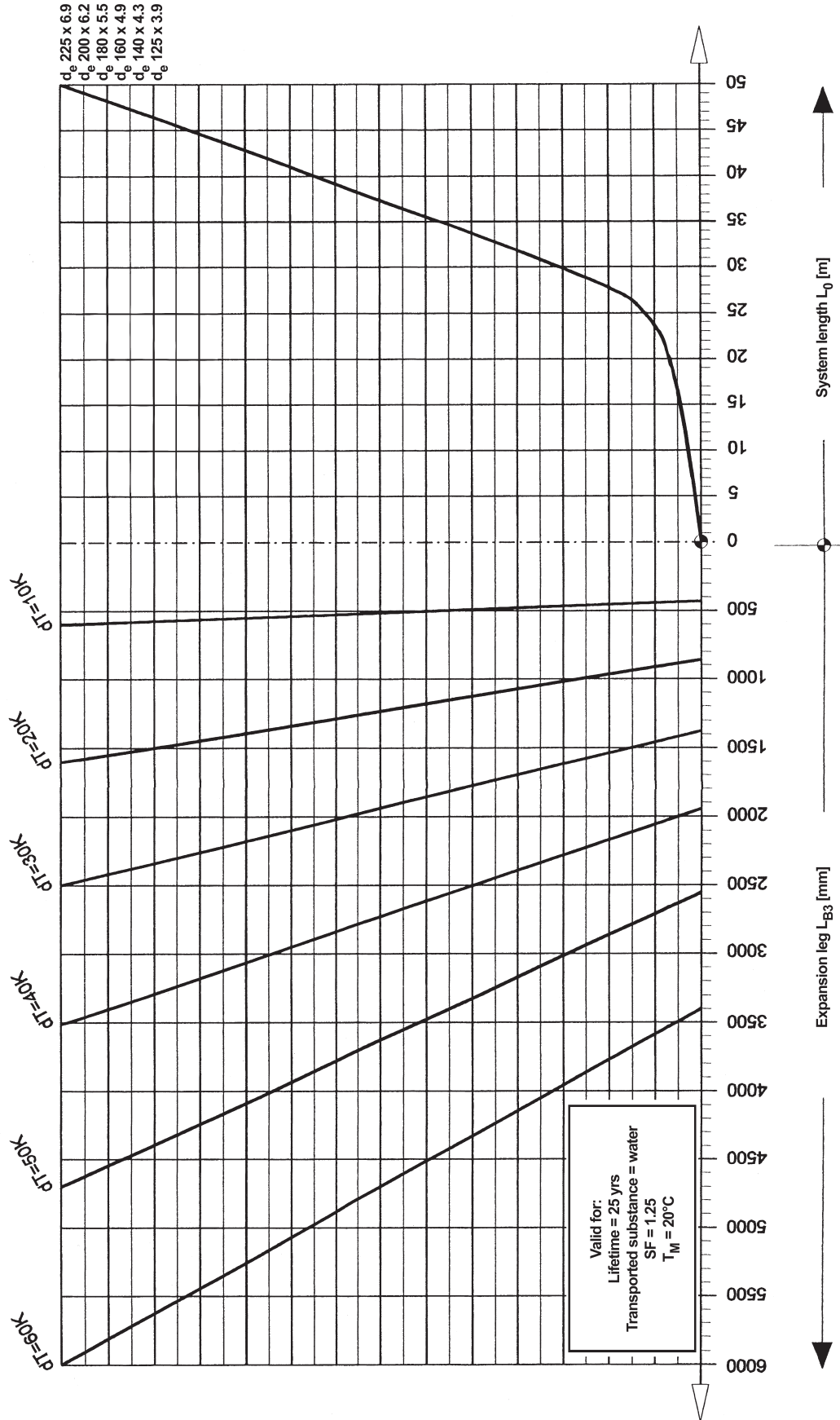

5.3.4 Loads on anchors

Plastic pipes laid above ground require a fixing system. The fixing system must assure that the pipeline is sufficiently supported, properly positioned, and designed so that no loads beyond permissible limits occur during operation from inadequate fixing.

A fixing system needs a number of different installation devices with various functions. An essential element of installation is the immovable anchor; its restraining function requires it to accept the greatest forces.

Loads on an anchor element derive from the following test and working conditions:

- Internal pressure test
- Restraining expansion/contraction
- Friction with pipe supports
- Internal pressure when bellows-type expansion joints or socket expansion joints are used

Without calculations it is not possible to know which of these will give maximum load. Since operating conditions vary widely, this simplified determination of pipelaying parameters will consider only the load on anchors in the longitudinal pipe direction from restraining thermal expansion. For various materials, diagrams are provided to determine this load (see section 10 Explanations [6]).

The anchor load just determined is restricted to load from prevention of thermal expansion. Now other influences on the anchor load will be examined (see section 10 Explanations [7]).

Anchor Forces in Axially Constrained Plastic Pipelines Material: PE 80 / PE 100

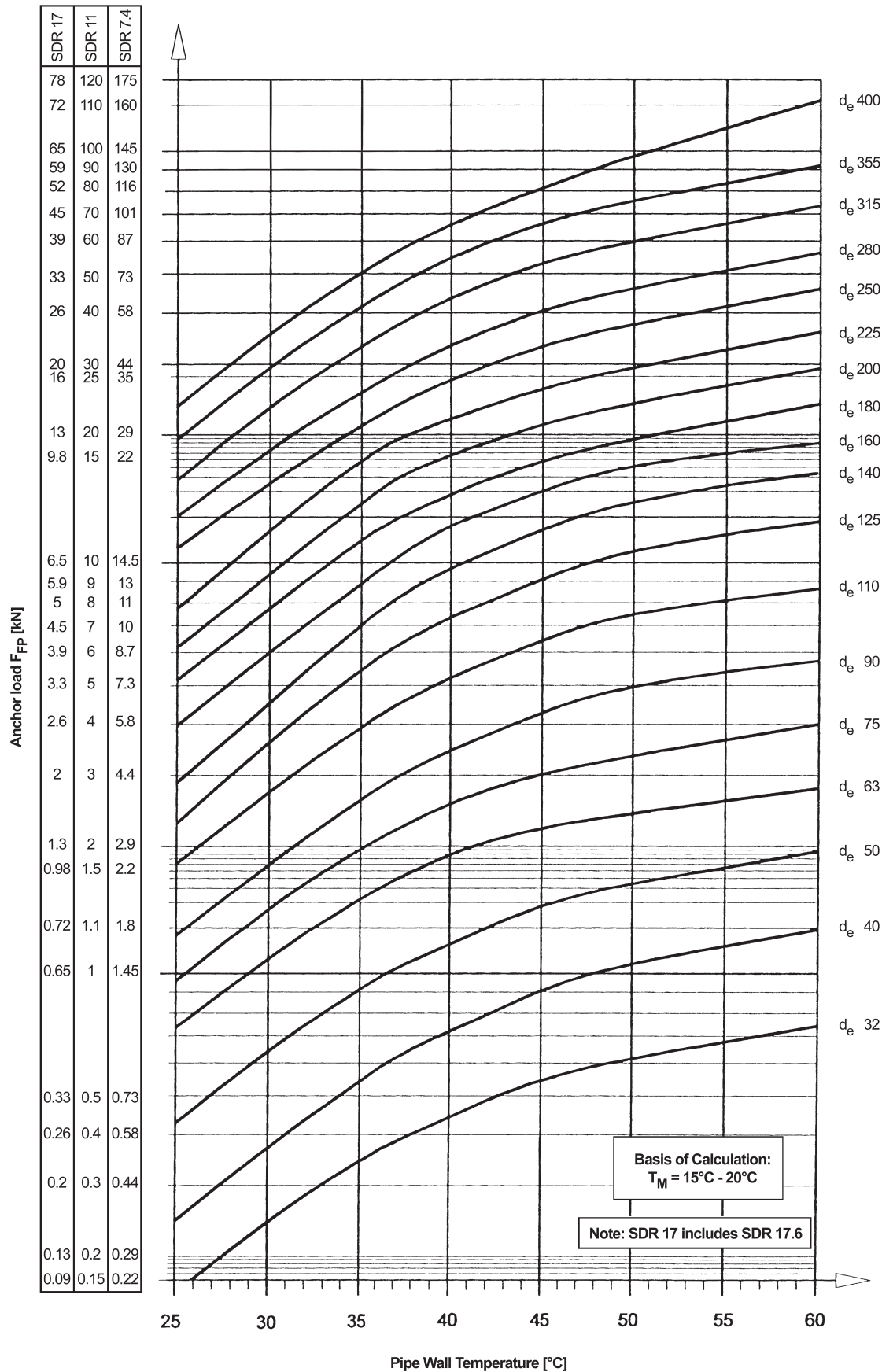

Anchor Forces in Axially Constrained Plastic Pipelines Material: PP-H/ PP-R

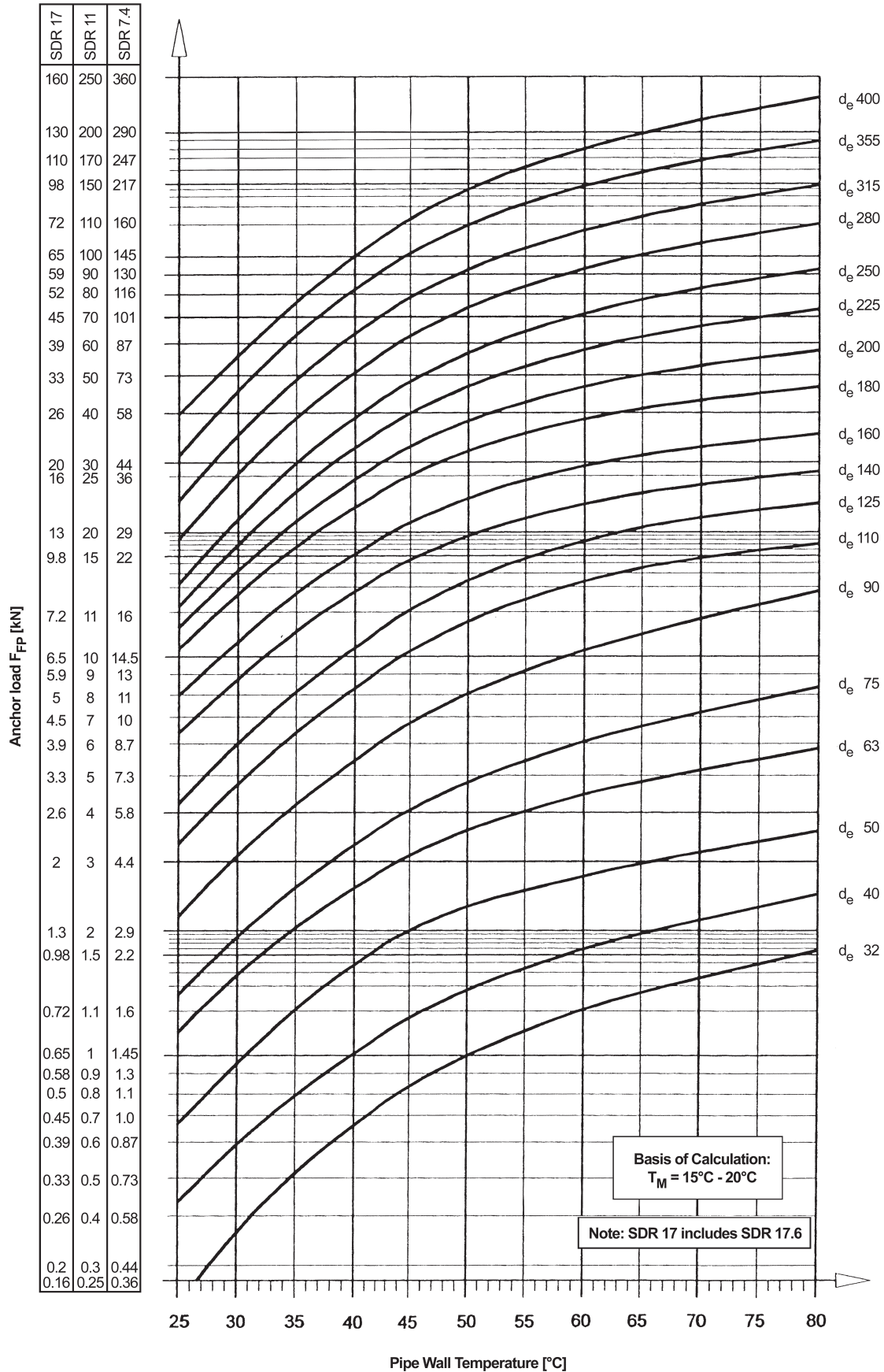

Anchor Forces in Axially Constrained Plastic Pipelines Material: PVDF d_e 16 to 110

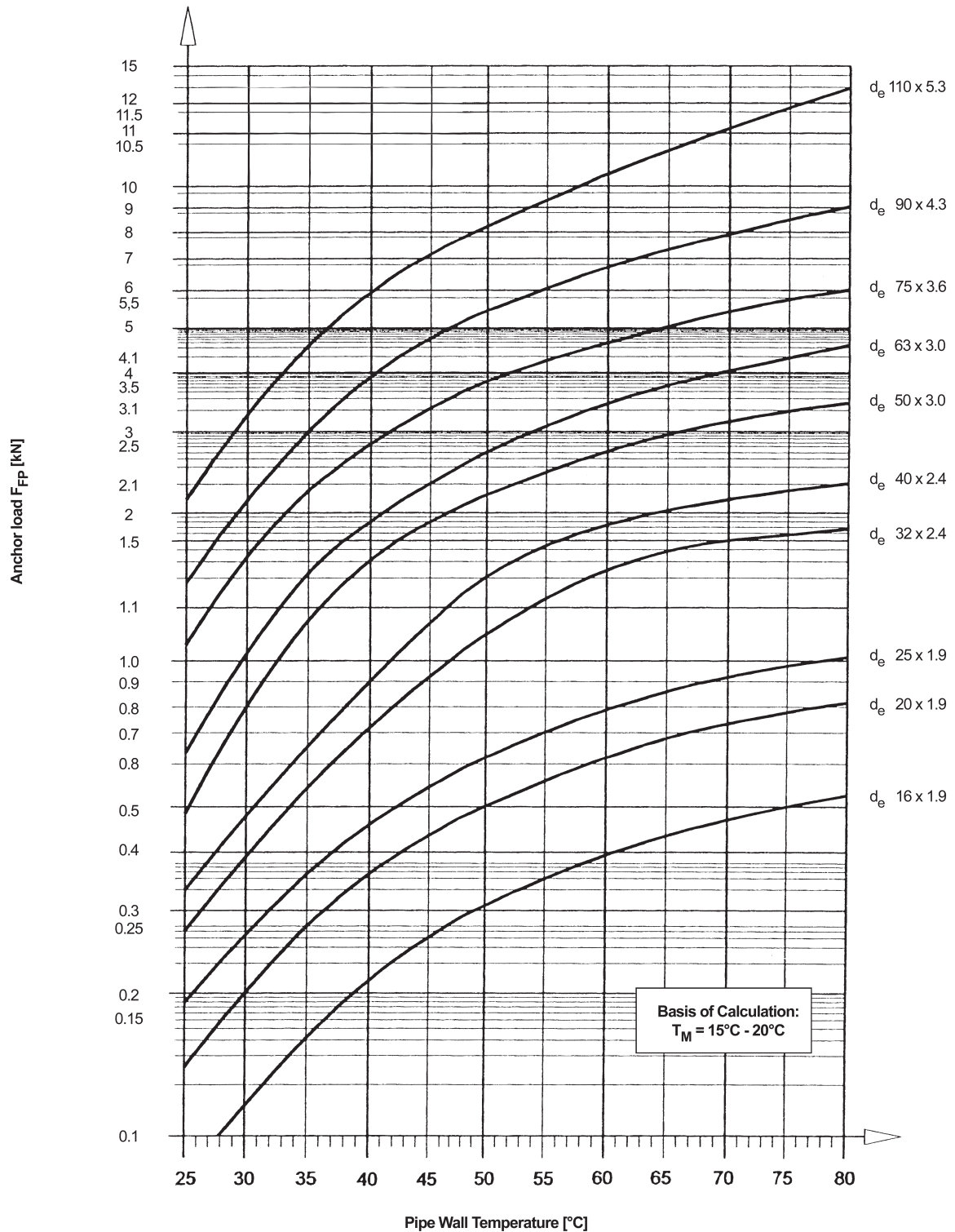

Anchor Forces in Axially Constrained Plastic Pipelines
Material: PVDF d_e 125 to 225

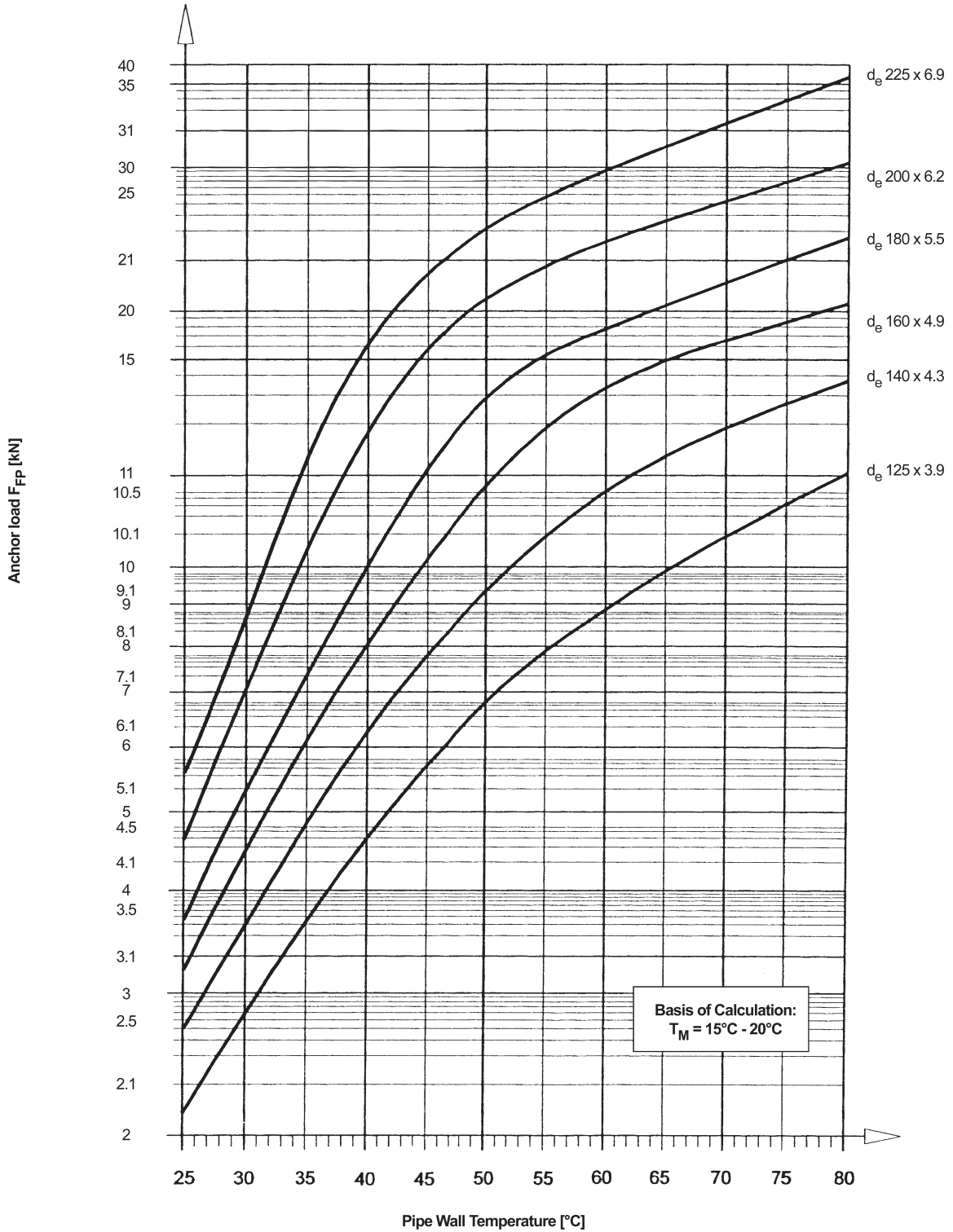

5.3.5 Distance between mounting devices

When installing plastic pipelines above ground, it must be assured that pipe movement and sagging remain within permissible limits. The relevant factor for the permissible magnitude of sagging (bending between supports) is given by the elastic line of a solid beam of the same cross section as the pipe. Typical values are: $f = L/500$ to $L/750$.

Here:

L = spacing between supports or hangers

f = largest deflection between supports or hangers

Sag considerations depend on the lifetime selected for the pipeline. Typical lifetimes for industrial and public works supply lines are given in sec. 4.2.2.

Besides sagging, which affects the required distance between supports, one must consider a second factor: the danger that the plastic pipeline collapses. This collapse (buckling under axial compression) can happen if the pipe run is prevented from expanding from temperature increase, and is in essence axially constrained.

This prevention of expansion leads to compression stress. At high stress, the critical collapse load can be exceeded. This leads to instability in the pipe length, which can be regarded as a “support”, between adjacent mounting points. To prevent collapse, the pipe mounting distance = the distance between guides has to be suitable for the critical collapse load. That is, the larger the collapse load, the closer together the guides must be.

These plastic pipeline behaviors must be prevented by limits on the support span. SIMONA Diagrams address this problem. The danger of collapse affects mostly small-diameter pipe; for which the permissible distance between supports must be small to prevent sagging as well.

What is more important, the permissible support interval or required distance between guides depends on material, temperature, and diameter. This information is given in Table 7 for the cases considered in the SIMONA Diagrams.

Table 7: Support spacing and required guide distance

Material	T_o	Ruling Measurement		T_o	Ruling Measurement	
		L_{supp}	L_{guide}		L_{supp}	L_{guide}
PE	$\leq 30^\circ\text{C}$	$d_e > 32$	$d_e \leq 32$	$> 30^\circ\text{C}$	$d_e > 75$	$d_e \leq 75$
PP	$\leq 40^\circ\text{C}$	$d_e > 75$	$d_e \leq 75$	$> 40^\circ\text{C}$	$d_e > 140$	$d_e \leq 140$
PVDF	$\leq 40^\circ\text{C}$	$d_e > 63$	$d_e \leq 63$	$> 40^\circ\text{C}$	$d_e > 110$	$d_e \leq 110$

LAYING PLASTIC PIPES ABOVE GROUND

The table shows, for pipelines made of different thermoplastics, which of the two factors is most important. Looking at line 1, for PE pipe, one sees that for pipes of diameter $d_e = 40$ mm or larger and working temperature up to 30°C , the support distance L_{supp} is the limiting distance. This also implies that all pipes with diameter under d_e of 40 would collapse under thermal expansion if supports are no closer than at the support distance designed to prevent sagging.

If working temperature is above 30°C , then the limit for using the customary support distance (preventing sagging) without danger of collapse goes from $d_e = 32$ to $d_e = 75$ mm. Customary distances means those given in DVS Guideline 2210-1.

The SIMONA diagrams have been composed to avoid differentiating in this way. They integrate the two possibilities, so that a safe pipe installation is possible, whether the pipe is free to expand or is axially constrained by anchors.

When using the diagrams, note that they are for the case of water and other materials with density 1.0 g/cm^3 , which do not compromise the mechanical properties of the pipeline material. Some materials transported in pipelines can cause e.g. swelling and compromise the strength properties. Please refer to SIMONA® SIMCHEM for information regarding through-put materials.

This example demonstrates how to determine the permissible mounting distance for a thermoplastic pipeline by using SIMONA Diagrams (see section 10 Explanations [8]).

Supported Distances for PE 80/PE 100 Plastic Pipelines

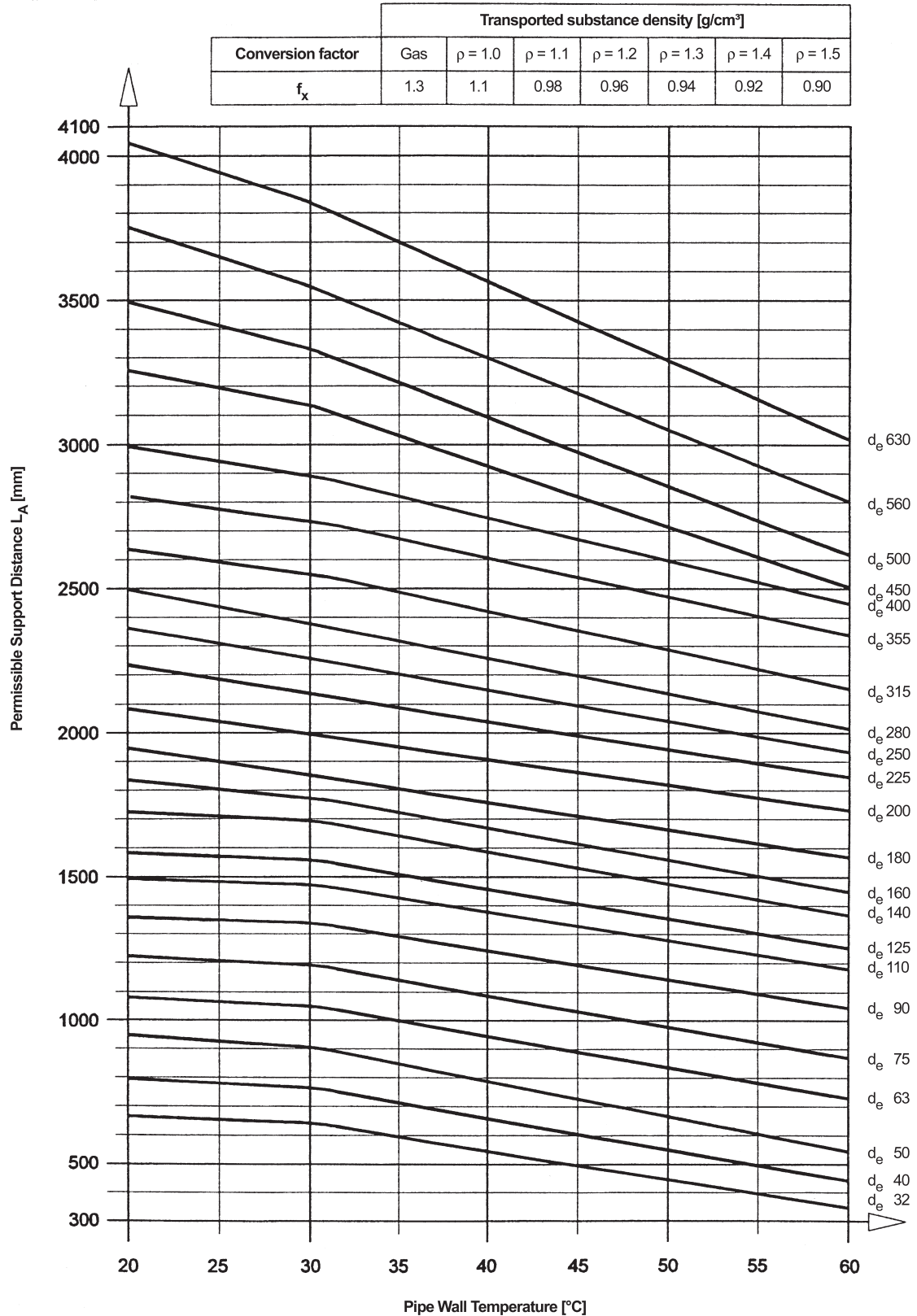

Supported Distances for PP-H/PP-R Plastic Pipelines

Conversion factor	Transported substance density [g/cm ³]						
	Gas	$\rho = 1.0$	$\rho = 1.1$	$\rho = 1.2$	$\rho = 1.3$	$\rho = 1.4$	$\rho = 1.5$
f_x	1.3	1.1	0.98	0.96	0.94	0.92	0.90

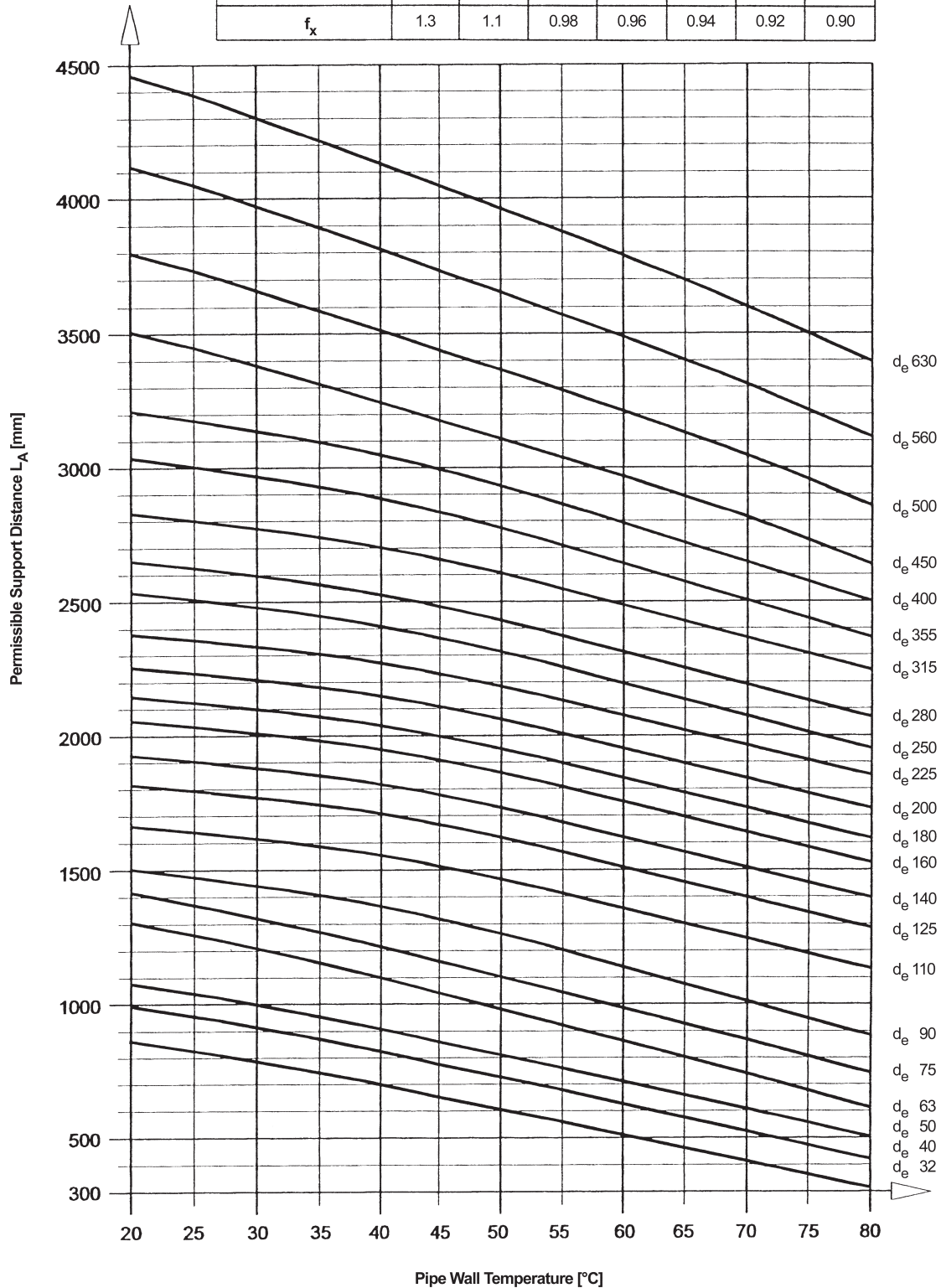

Supported Distances for PVDF Plastic Pipelines

$d_e = 16$ to 110

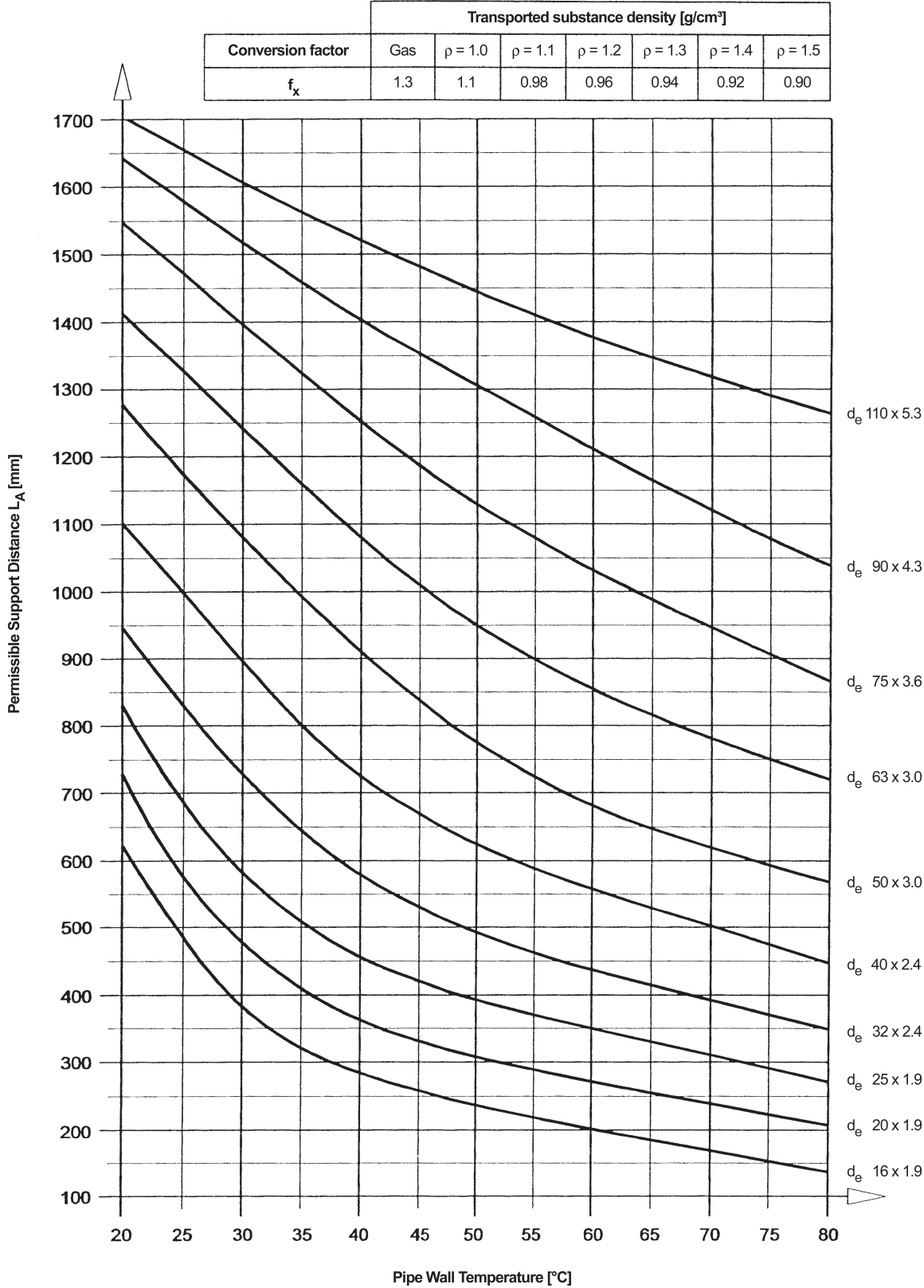

Supported Distances for PVDF Plastic Pipelines $d_e = 125$ to 225

Conversion factor	Transported substance density [g/cm ³]						
	Gas	$\rho = 1.0$	$\rho = 1.1$	$\rho = 1.2$	$\rho = 1.3$	$\rho = 1.4$	$\rho = 1.5$
f_x	1.3	1.1	0.98	0.96	0.94	0.92	0.90

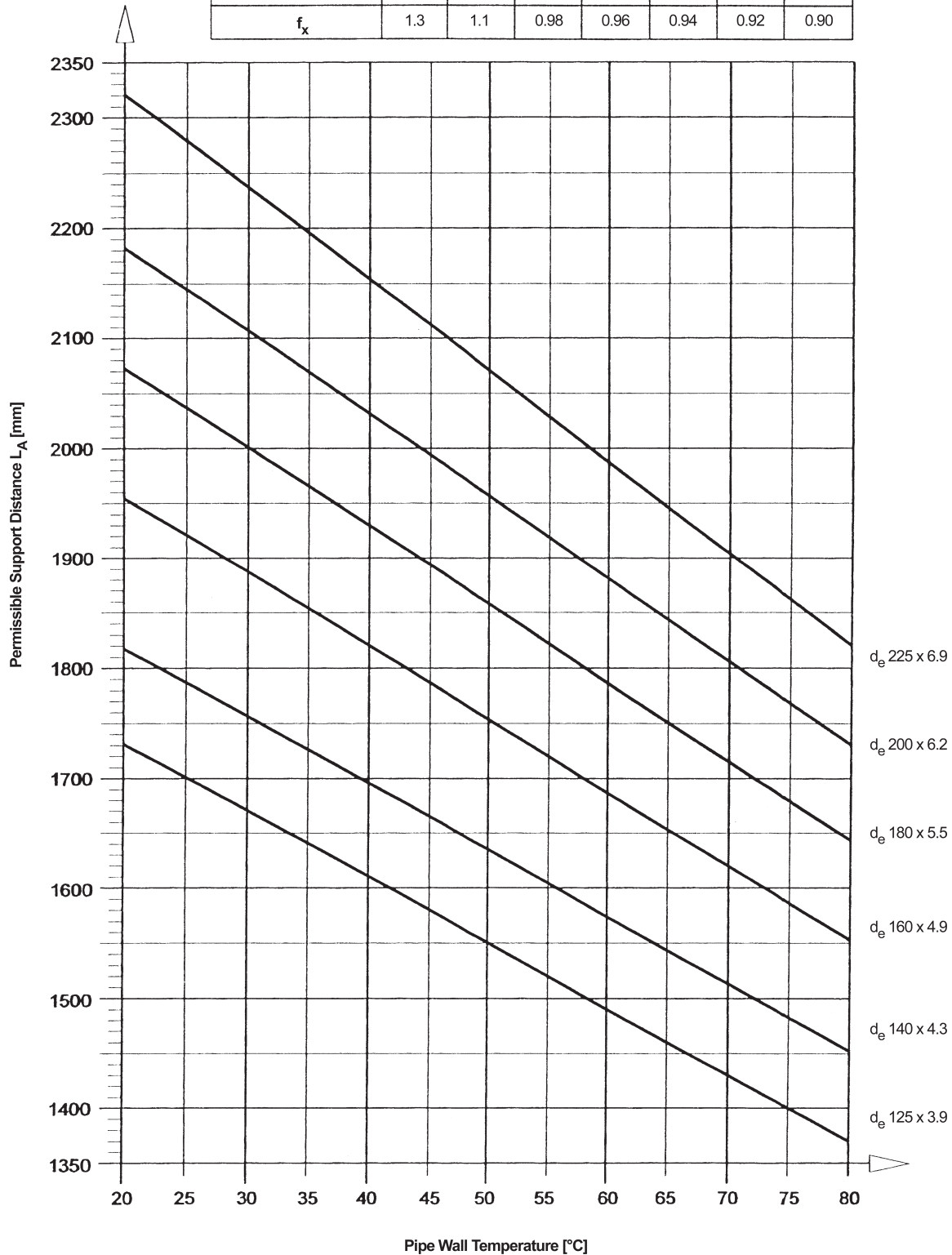

5.4 Testing

For testing pipelines installed above or below ground, the sole responsibility lies with the (technically trained) builder of the pipeline.

Generally accepted technical practice in pipeline construction and the standards and guidelines currently in effect (e.g. DVS Guidelines) are to be followed.

5.4.1 Testing plastic pressure pipelines

DVS Guideline DVS 2210-1 and supplement 2 (Industrial pipe systems), DIN EN 805/DVGW W 400-2 (watersupply systems) stipulate that plastic pipelines are to be tested with internal pressure testing.

Destructive testing serves mainly to prove strength properties, e.g. of welds. Internal pressure tests are typically carried out on fully installed pipelines.

5.4.2 Testing plastic pipelines not working under pressure

Testing of plastic pipelines not working under pressure, e.g. underground sewers, follows the directions in DIN EN 1610 (the elder DIN 4033) for laying and testing wastewater pipelines and sewers.

6 Welding

6.1	Welding	95
6.1.1	Welding PE-HD, PP and PVDF pipes and fittings	95
6.1.2	Butt welding	96
6.1.3	Socket welding	99
6.1.4	Electro fusion welding	101

6.1 Welding

6.1.1 Welding PE-HD, PP and PVDF pipes and fittings

PE 80, PE 100, PE 100 RC, PE-EL

According to the Technical Code DVS 2207, Part 1 the suitability requirement for welding is Melt Flow Rate MFR 190/5 (Previously called MFI = Melt Flow Index), i. e. 0.3–1.7 g/10 min.

PP-H, PP-R

With Melt Flow Rate within MFR 190/5, i. e. 0.4–1.0 g/10 min., these are suitable for welding. Please refer to Technical Code DVS 2207, Part 11.

Fundamentally the same welding suitability holds for PP-H or PP-R with the same parameters.

PVDF

With Melt Flow Rate within MFR 230/5, i. e. 1,0–25 g/10 min. Please refer to Technical Code DVS 2207, Part 15.

General requirements

The welding area is to be protected from harmful weather, e. g. moisture, wind, intense sunlight, and temperatures below 5 °C.

When an even, appropriate welding temperature can be maintained for the pipe walls, then welding is possible at any outside temperature. This may involve:

- Preheating
- Protective shelter
- Heating up.

In direct sunlight, cover the weld area in advance, to allow temperature differences in unevenly warmed pipe to equalize. In strong wind, close off the extreme ends of the pipe segments to prevent cooling the weld during the welding process.

Welding methods

To achieve a permanent bond with SIMONA® pipes and fittings, we recommend the processes that have proven themselves in practice:

- butt welding
- socket welding
- electro fusion welding.

6.1.2 Butt welding

Before butt welding, the two surfaces to be welded are heated to welding temperature by a heating plate. It is then removed and the two plasticized surfaces are pressed together to form a weld.

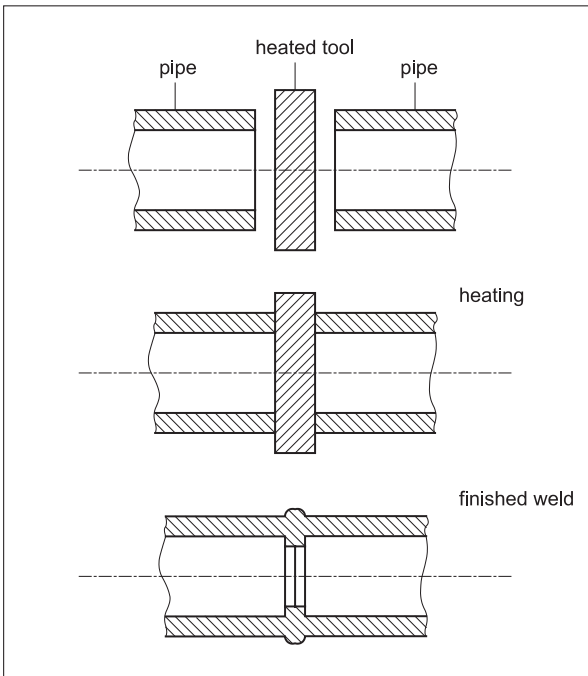

Fig. 2: Heated tool butt welding

Weld preparation

The pipeline components are laid out axially before being clamped into the welding machine. The part to be welded on must be free to move along the axis, with the help of e.g. adjustable pulleys if necessary.

With a planer, machine off the surfaces to be bonded, after they have been clamped into place. If swarf happens to fall into the pipe, use a clean tool to remove them. A hand must never touch the surfaces planed for welding.

After planning, check that the surfaces are parallel. Any gap remaining must be no greater than the maximum in Table 9. As well, check that any mismatch of the pipe ends is smaller than 10% of the pipe wall thickness. If not, the wall thicknesses are to be matched around the weld by machining.

Table 9: Maximum gap before welding

Pipe d	Max. gap
≤ 355	0.5
400 to < 630	1.0
630 to < 800	1.3
800 to ≤ 1000	1.5

Welding process

The heating plate is heated to welding temperature and placed between the surfaces to be welded. They are pressed against the heated tool with the correct matching pressure. The temperature is monitored with a rapidly registering surface thermometer.

The force for matching or welding can be calculated from the weld surface and the specific pressure. Usually the welding machine manufacturers give pressure values in table form, since most machines work with hydraulics, not with measured forces. To this pressure value, add the drag pressure from the movement of the work piece. The latter is influenced by friction of machine parts and the weight of the pipes and fittings to be welded.

Bead-up time is completed only after a bead (according to Tables 10–12) has formed completely around both ends to be welded. The heating time begins at this point, and the pressure is reduced to nearly zero.

After heating, the fusion surfaces are detached from the heating plate without damage or contamination. The time for detaching the fusion surfaces, removing the heating plate, and bringing the fusion surfaces

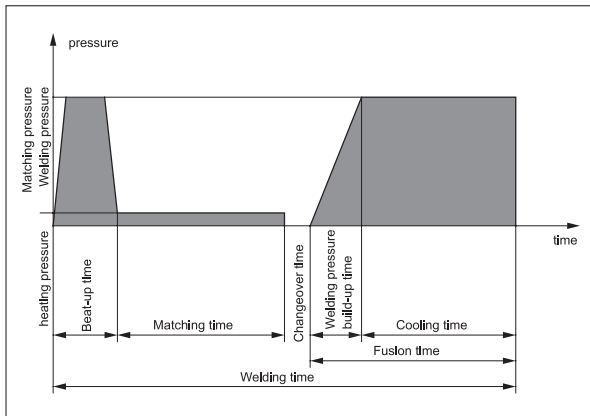

Fig. 3: Steps in heated tool butt welding

into contact with each other is called the changeover time. It should be kept as short as possible.

The weld surfaces should be brought into contact gently, at extremely low speed. Then pressure is slowly increased (for times see Tables 10–12), then maintained until cooling is complete.

Never accelerate weld cooling or apply coolant to the area. For pipe walls 20 mm or more in thickness, an even cooling for a better weld can be achieved by covering the weld area during the cooling phase. After welding a double bead must go completely around the weld, as in Fig. 4.

If the bead is to be removed, it should be done before the weld is entirely cooled down. Machining the bead off the cold weld runs the risk of causing dents. With brittle materials like PVDF it can cause chipping.

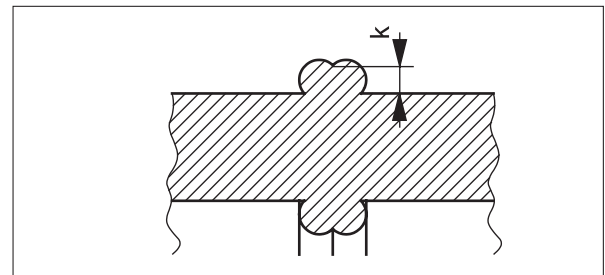

Fig. 4: Bead from butt welding

Table 10: Recommended values for butt welding, PE 80/PE 100/PE 100 RC/PE-EL pipes and fittings^①

Wall thickness	Matching ^②	Heat up ^③	Changeover	Welding ^④	
	Heat up time starts	Heat up time	Changeover time	Weld pressure build-up time	Cooling time
mm	mm	s	s (max. time)	s	min (min. time)
up to 4.5	0.5	45	5	5	6
4.5–7	1.0	45–70	5–6	5–6	6–10
7–12	1.5	70–120	6–8	6–8	10–16
12–19	2.0	120–190	8–10	8–11	16–24
19–26	2.5	190–260	10–12	11–14	24–32
26–37	3.0	260–370	12–16	14–19	32–45
37–50	3.5	370–500	16–20	19–25	45–60
50–70	4.0	500–700	20–25	25–35	60–80

① For outdoors temperature about 20°C and moderate air movement

② Height of bead on the heated tool at the end of the matching time (matching at < 0.15 N/mm²)

③ Heated tool temperature is 210 ± 10°C, heat up time = 10 x wall thickness (heat soak at ≤ 0.02 N/mm²)

④ Cooling time at welding pressure (p = 0.15 ± 0.01 N/mm²)

WELDING

Table 11: Recommended values for butt welding, PP-H/PP-R pipes and fittings^①

Wall thickness	Matching ^②	Heat up ^③	Changeover	Welding ^④	
	Heat up time starts	Heat up time	Changeover time	Weld pressure build-up time	Cooling time
mm	mm	s	s (max. time)	s	min (min. time)
up to 4.5	0.5	up to 135	5	6	6
4.5–7	0.5	135–175	5–6	6–7	6–12
7–12	1.0	175–245	6–7	7–11	12–20
12–19	1.0	245–330	7–9	11–17	20–30
19–26	1.5	330–400	9–11	17–22	30–40
26–37	2.0	400–485	11–14	22–32	40–55
37–50	2.5	485–560	14–17	32–43	55–70

① The particular machine and working conditions may make it impossible to use these recommended values, especially the heat up time.

If so, test samples should be made and tested.

② Heated tool temperature is $210 \pm 10^\circ\text{C}$. Height of bead on the heated tool at the end of the bead-up time (matching at 0.10 N/mm^2)

③ Heat up at $\leq 0.02 \text{ N/mm}^2$

④ Cooling time at welding pressure ($p = 0.10 \pm 0.01 \text{ N/mm}^2$)

Table 12: Recommended values for butt welding, PVDF pipes and fittings^①

Wall thickness	Matching ^②	Heat up ^③	Changeover	Welding ^④	
	Heat up time starts	Heat up time	Changeover time	Weld pressure build-up time	Cooling time
mm	mm	s	s (max. time)	s	min (min. time)
1.9–3.5	0.5	59–75	3	3–4	5–6
3.5–5.5	0.5	75–95	3	4–5	6–8.5
5.5–10.0	0.5–1.0	95–140	4	5–7	8.5–14
10.0–15.0	1.0–1.3	140–190	4	7–9	14–19
15.0–20.0	1.3–1.7	190–240	5	9–11	19–25
20.0–25.0	1.7–2.0	240–290	5	11–13	25–32

① The particular machine and working conditions may make it impossible to use these recommended values, especially the heat up time. If so, test samples should be made and tested.

② Height of bead on the heated tool at the end of the matching time (matching at 0.10 N/mm^2)

③ Heat up time = $10 \times \text{wall thickness} + 40 \text{ s}$ (heat up at $= 0.01 \text{ N/mm}^2$)

④ Cooling time at welding pressure ($p = 0.10 \text{ N/mm}^2 \pm 0.01$), cooling time = $1.2 \times \text{wall thickness} + 2 \text{ min}$.

6.1.3 Socket welding (HD)

In heated tool socket welding, pipe and fittings are welded with an overlap. A heating tool (or tools) with socket and plug-shaped faces is used to heat the two pieces to be welded; they are then brought together and fused. The pipe end, heating tool, and fitting socket are matched so that fusion pressure is built up during fusion.

When the pipe diameter is:

- > 63 mm for PE 80, PE 100, and PP
- > 50 mm for PVDF

a suitable welding equipment should be used.

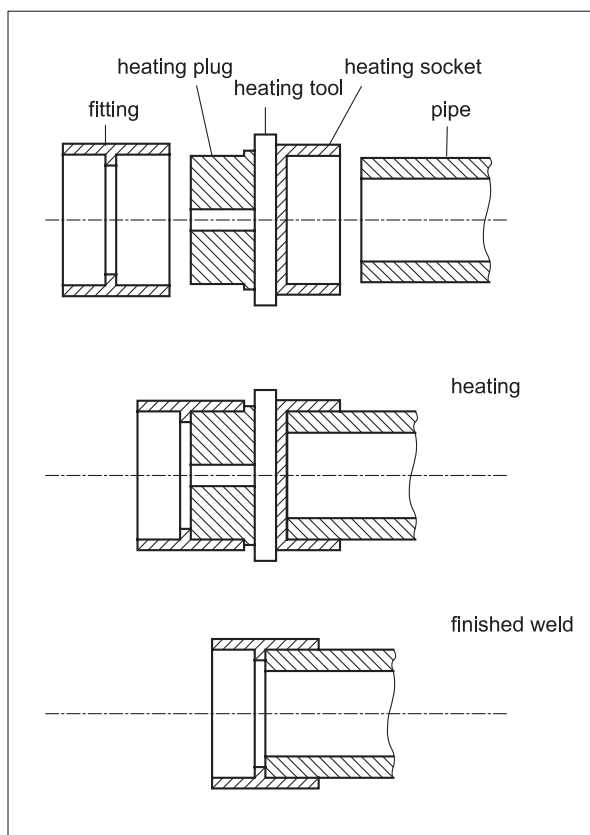

Fig. 5: Socket welding

Weld surface preparation

The surfaces to be bonded are rough-turned or scraped. The fitting is thoroughly cleaned with a cleaning solution, e.g. with alcohol and absorbent lint-free paper.

The pipe end is machined down on the outside to a 15° slant on the last:

- 2 mm for diameters up to 50 mm
- 3 mm for larger diameters

Then it is marked to show how far it will be inserted into the heating tool.

Welding process

The tools are heated to $260 \pm 10^\circ\text{C}$. The temperature is monitored with a rapidly registering surface thermometer. For heating, the fitting is slid onto the heating tool as far as it goes, and the pipe is inserted up to the mark. The parts are heated according to the times given in Tables 13 and 14.

At the end of the heating time, the fitting and pipe are removed from the heated tool with a jerk, and the pipe inserted straight into the fitting, without twisting, up to the pipe marking or a stop in the fitting. The fused parts must cool undisturbed for the same time as recommended for heating.

WELDING

Table 13: Recommended values for socket welding, PE-HD and PP pipes and fittings^①

Pipe d mm	Heating time		Changeover time	Cooling time	
	Pipe PN 10 ^② s	Pipe PN 6 ^③ s	max. permissible s	clamped s	total min
16	5		4	6	2
20	5		4	6	2
25	7	②	4	10	2
32	8	②	6	10	4
40	12	②	6	20	4
50	12	②	6	20	4
63	24	12 ^②	8	30	6
75	30	15	8	30	6
90	40	22	8	40	6
110	50	30	10	50	8
125	60	35	10	60	8

① For outdoor temperature about 20°C and moderate air movement

② For PP. Not advisable for PE-HD.

③ Not advisable at this wall thickness

Table 14: Recommended values for heated tool socket welding, PVDF pipes and fittings

Pipe d mm	Heating time s	Changeover time max. permissible s	Cooling time	
			clamped s	total min
16	4	4	6	2
20	6	4	6	2
25	8	4	6	2
32	10	4	12	4
40	12	4	12	4
50	18	4	12	4
63	20	6	18	6
75	22	6	18	6
90	25	6	18	6
110	30	6	24	8

6.1.4 Electro fusion welding (HM)

The surfaces to be welded, i.e. the pipe outer surface and the socket inside surface, are heated to welding temperature and fused by electric current, through the resistance of wires within the socket.

Weld surface preparation

For a good electro fusion weld, clean surfaces are an important factor. The pipe surfaces must be shaved in the weld area. Then the burr on the inner edge must be removed and the outer edge rounded, see Fig. 7. The fitting is thoroughly cleaned inside with an appropriate cleaning solution and absorbent lint-free paper. In the weld area, the pipe may be out of the round by no more than 1.5%. Otherwise clamps for this purpose can be used to force roundness.

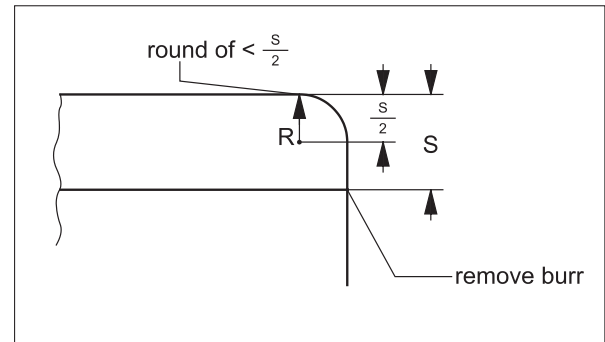

Fig. 7: Preparing pipe ends

When the fitting goes on to the pipe ends, keep it straight along the axis and avoid forcing. This prevents displacing and damaging the resistance wire.

Welding process

The welding device must match the fitting used. Settings on the device are selected before welding, according to the pipe diameter and nominal pressure. Welding cables connect device and fitting. Fusion is carried out automatically, and the weld is left at rest until thoroughly cooled.

For all welding processes, the applicable DVS Guidelines are to be followed.

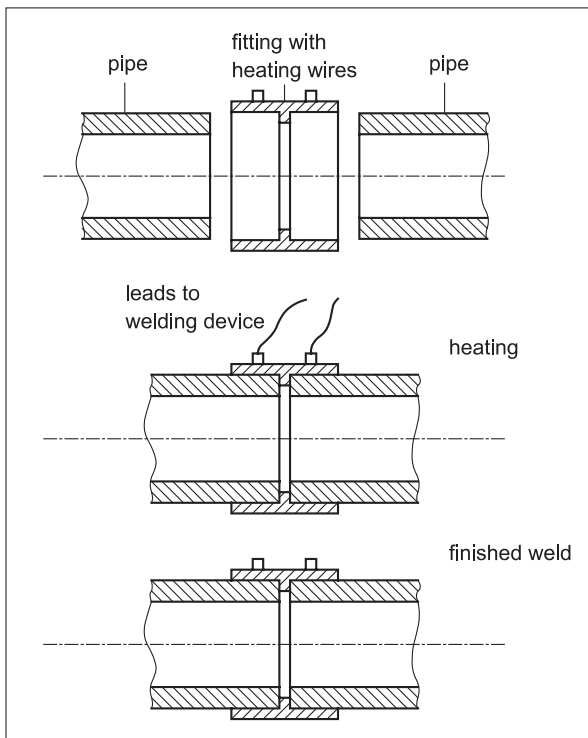

Fig. 6: Electro fusion welding

7 Classification of nominal diameters

7.1	Classification of nominal diameters for PE-HD and PP	103
7.2	Correlation between SDR and PN	104

7.1 Classification of nominal diameters for PE-HD and PP

Nom. Diameter	pipe	SDR 41	SDR 33	SDR 26	SDR 17 [Ⓢ]	SDR 11	SDR 9	SDR 7.4	
	DN	d mm	PN 2.5	PN 3.2	PN 4	PN 6	PN 10	PN 12.5 [Ⓢ]	PN 16 [Ⓢ]
		e mm	e mm	e mm	e mm	e mm	e mm	e mm	e mm
6	10							1.8	
8	12							2.0	
10	16						1.8	2.2	
15	20					1.9	2.3	2.8	
20	25					2.3	2.8		
20	32							4.4	
25	32				1.8	2.9	3.6		
32	40			1.8	2.3	3.7	4.5		
32	50							6.9	
40	50			2.0	2.9	4.6	5.6		
40	63							8.6	
50	63	1.8	2.0	2.5	3.6	5.8	7.1		
50	75	1.9						10.3	
65	75	1.9	2.3	2.9	4.3	6.8			
65	90						10.1	12.3	
80	90	2.2	2.8	3.5	5.1	8.2			
80	110						12.3	15.1	
100	110	2.7	3.4	4.2	6.3				
100	125					11.4	14.9		
100	140							19.2	
125	125	3.1	3.9	4.8					
125	140	3.5	4.3	5.4	8.0				
125	160					14.6	17.8		
125	180							24.6	
150	160	4.0	4.9	6.2					
150	180				10.2	16.4			
150	200						22.3	27.4	
200	200	4.9	6.2						
200	225		6.9	8.6	12.8				
200	250					22.7	27.9		
200	280							38.3	
250	250	6.2	7.7						
250	280		8.6	10.7	15.9				
250	315					28.6	35.2		
250	355							48.5	
300	315	7.7	9.7	12.2					
300	355				20.1	32.2			
300	400						44.7		
350	355	8.7	10.9						
350	400			15.3	22.7				
350	450					40.9	50.3		
400	400	9.8							
400	450		13.8	17.2	25.5				
400	500					45.4			
450	450	11.0							
450	500		15.3	19.1	28.4	45.4			
500	500	12.2							
500	560		17.2	21.4	31.7				
500	630				35.7				
600	630	15.4	19.3	24.1					
600	710			27.2	40.2				
700	710	17.4	21.8						
800	800		24.5	30.6	45.3				
900	900		27.6	34.4					
1000	1000		30.6	38.2					

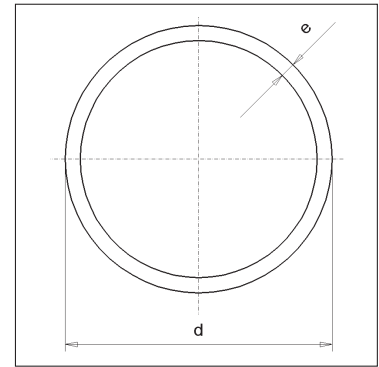

The table contains all conversions theoretically possible from the measurement standards. Not all measurement conversions listed correspond to items we produce. When selecting nominal diameter, consider any flange connection dimensions involved.

Ⓢ Includes SDR 17.6

Ⓢ Mass standards and DIN 8077 contain no measurements for PN 12.5 (SDR 9).

7.2 Correlation between SDR and PN

	PE 80	PE 100	PE 80	PP-H AlphaPlus®	PP-R	PVDF	E-CTFE
Safety factor SF	1.25	1.25	1.6	1.6	1.25	2.0	2.5
SDR	PN ^①						
51	2.5	3.2					
41	3.2	4.0	2.5	3.1	3.9		
33	4.0	5.0	3.2	3.9	4.9	10.0	
26	5.0	6.3	4.0	5.0	6.2		
22	6.0	~ 7.6					
21	6.3	8.0	5.0			16.0	10.0
17.6	~ 7.6	~ 9.7	6.0	7.5	9.3		
17	8.0	10.0	6.3				
13.6	10.0	12.5	8.0				
11	12.5	16.0	10.0	12.5	15.5		
9	~ 16.0	20.0	12.5				
7.4	20.0	25.0	~ 16.0	19.8	24.5		
6	25.0						

① PN applies to water at 20 °C and a calculated service life of 50 years.

In the case of welded fittings made of pipe, pressure reduction factors may be applicable depending on the type.

Note

Some of the PE 100 fittings are indicated with the SDR denomination SDR 17/17.6. These items are produced within the tolerance range of SDR 17 and SDR 17.6. These fittings can consequently be connected to component parts of pressure rating SDR 17 or SDR 17.6 by heated element butt welding and, if suitable, by heated coil welding (with elongated spigots) as well.

8 Tolerances

8.1	Tolerances for pipes out of PE-HD (PE 80, PE 100) and PP	107
8.1.1	Wall thickness deviation limits	107
8.1.2	Average outer diameter deviation limits	108
8.1.3	Length deviation limits	108
8.1.4	Ovality deviation limits	109

8.2	Tolerances for pipes out of PVDF	110
8.2.1	Wall thickness deviation limits	110
8.2.2	Average outer diameter deviation limits	110
8.2.3	Length deviation limits	110

8.1 Tolerances for pipes out of PE-HD (PE 80, PE 100) and PP

8.1.1 Wall thickness deviation limits

Wall thickness deviation limits	
Wall thickness	Deviation limit ^①
e mm	+... 0
≤ 2	0.4
> 2 ≤ 3	0.5
> 3 ≤ 4	0.6
> 4 ≤ 5	0.7
> 5 ≤ 6	0.8
> 6 ≤ 7	0.9
> 7 ≤ 8	1.0
> 8 ≤ 9	1.1
> 9 ≤ 10	1.2
> 10 ≤ 11	1.3
> 11 ≤ 12	1.4
> 12 ≤ 13	1.5
> 13 ≤ 14	1.6
> 14 ≤ 15	1.7
> 15 ≤ 16	1.8
> 16 ≤ 17	1.9
> 17 ≤ 18	2.0
> 18 ≤ 19	2.1
> 19 ≤ 20	2.2
> 20 ≤ 21	2.3
> 21 ≤ 22	2.4
> 22 ≤ 23	2.5
> 23 ≤ 24	2.6
> 24 ≤ 25	2.7
> 25 ≤ 26	2.8
> 26 ≤ 27	2.9
> 27 ≤ 28	3.0
> 28 ≤ 29	3.1
> 29 ≤ 30	3.2
> 30 ≤ 31	3.3
> 31 ≤ 32	3.4
> 32 ≤ 33	3.5
> 33 ≤ 34	3.6
> 34 ≤ 35	3.7
> 35 ≤ 36	3.8
> 36 ≤ 37	3.9
> 37 ≤ 38	4.0
> 38 ≤ 39	4.1
> 39 ≤ 40	4.2

Wall thickness deviation limits	
Wall thickness	Deviation limit ^①
e mm	+... 0
> 40 ≤ 41	4.3
> 41 ≤ 42	4.4
> 42 ≤ 43	4.5
> 43 ≤ 44	4.6
> 44 ≤ 45	4.7
> 45 ≤ 46	4.8
> 46 ≤ 47	4.9
> 47 ≤ 48	5.0
> 48 ≤ 49	5.1
> 49 ≤ 50	5.2
> 50 ≤ 51	5.3
> 51 ≤ 52	5.4
> 52 ≤ 53	5.5
> 53 ≤ 54	5.6
> 54 ≤ 55	5.7
> 55 ≤ 56	5.8
> 56 ≤ 57	5.9
> 57 ≤ 58	6.0
> 58 ≤ 59	6.1
> 59 ≤ 60	6.2
> 60 ≤ 61	6.3
> 61 ≤ 62	6.4
> 62 ≤ 63	6.5
> 63 ≤ 64	6.6
> 64 ≤ 65	6.7
> 65 ≤ 66	6.8
> 66 ≤ 67	6.9
> 67 ≤ 68	7.0
> 68 ≤ 69	7.1
> 69 ≤ 70	7.2

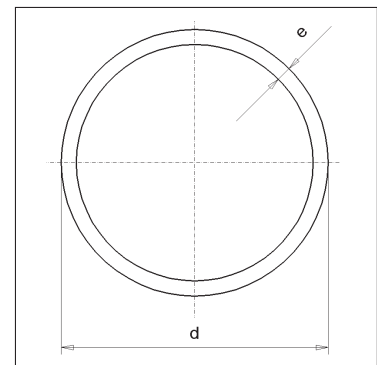

① The values were calculated from the equation:
 Wall thickness deviation limit = 0.1 e + 0.2 mm, rounded up to the nearest 0.1 mm.
 This limit applies to the measured average value. The limit for any specific point on the circumference is 0.2 e for wall thickness e ≤ 10 mm, and 0.15 e for wall thickness e > 10 mm.

TOLERANCES

8.1.2 Average outer diameter deviation limits

Average outer diameter deviation limits

Outer diameter	Deviation limit ^{①②}
d_n mm	+... 0
10–32	0.3 (0.3)
40	0.4 (0.3)
50	0.5 (0.3)
63	0.6 (0.4)
75	0.7 (0.5)
90	0.9 (0.6)
110	1.0 (0.7)
125	1.2 (0.8)
140	1.3 (0.9)
160	1.5 (1.0)
180	1.7 (1.1)
200	1.8 (1.2)
225	2.1 (1.4)
250	2.3 (1.5)
280	2.6 (1.7)
315	2.9 (1.9)
355	3.2 (2.2)
400	3.6 (2.4)
450	3.8 (2.7)
500	4.0 (3.0)
560	4.3 (3.4)
630	4.6 (3.8)
710	4.9
800	5.0
1000	5.0

- ① The values were calculated from the equation: Average outer diameter deviation limit
- for $d \leq 400$ mm: $+ 0.009 d$, rounded up to the nearest 0.1 mm, but at least 0.3 mm
 - for $d = 450$ to 710 mm: $0.004 d + 2$ mm, rounded up to the nearest 0.1 mm
 - for $d = 800$ to 1000 mm: $+5.0$ mm
 - for $d = 1200$ to 1600 mm: $+6.0$ mm
- ② The values in parentheses are reduced average outer diameter limits applicable for electro fusion welding: $+0.006 d$, rounded up to the nearest 0.1 mm, but at least 0.3 mm.

8.1.3 Length deviation limits

Length deviation limits

Length	Permissible deviations
Coils	+ 1% 0%
≤ 12 m	± 10 mm

8.1.4 Ovality deviation limits

Outer diameter deviation limit^①

d mm	Straight lengths	Coil pipe
10	1.1	1.0
12	1.1	1.0
16	1.2	1.0
20	1.2	1.2
25	1.2	1.5
32	1.3	2.0
40	1.4	2.4
50	1.4	3.0
63	1.6	3.8
75	1.6	
90	1.8	
110	2.2	
125	2.5	
140	2.8	
160	3.2	
180	3.6	
200	4.0	
225	4.5	
250	5.0	
280	9.8	
315	11.1	
355	12.5	
400	14.0	
450	15.8	
500	17.5	
560	19.6	
630	22.1	
710	24.9	
800	28.0	
1000	25.0	

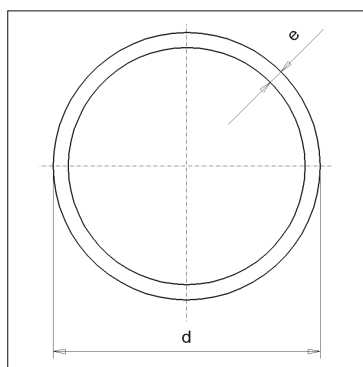

① The values were calculated from the equation: Ovality deviation limit for SDR 17.6 pipe:

- straight lengths: $d \leq 75$ mm: $0.008 \times d + 1$ mm, rounded up to the nearest 0.1 mm
- $d \geq 90$ mm ≤ 250 mm: $0.02 \times d$, rounded up to the nearest 0.1 mm
- $d > 250$ mm: $0.035 \times d$, rounded up to the nearest 0.1 mm
- coil pipe, $d \leq 63$ mm: $0.06 \times d$, rounded up to the nearest 0.1 mm, but at least 1.0 mm
- coil pipe, $d \geq 75$ mm: tolerance requirements to be specified in the terms of delivery (Source: DIN 8074/8077)

8.2 Tolerances for pipes out of PVDF (acc. to ISO 10931-2)

8.2.1 Wall thickness deviation limits

Wall thickness deviation limits

Wall thickness e [mm]	Deviation limit ^①
	+... 0
1.5–2.0	0.4
2.0–3.0	0.5
3.1–4.0	0.6
4.0–5.0	0.7
5.1–6.0	0.8
6.1–7.0	0.9

① The values were calculated from the equation: Permissible wall thickness deviation limit = $0.1 e + 0.2$ mm, rounded up to the nearest 0.1 mm. The limit for any specific point on the circumference is $+0.2 e$ for wall thickness $e \leq 10$ mm, and $0.15 e$ for wall thickness $e > 10$ mm. This limit applies to the measured average value.

8.2.2 Average outer diameter deviation limits

Average outer diameter deviation limits

Outer diameter d_n [mm]	Deviation ^{①②} limit
	+... 0
5–50	0.3
63–90	0.4
110	0.5
125	0.6
140	0.8
160	1.0
180	1.1
200	1.2
225	1.4
250	1.6
280	1.8
315	2.0

② The deviation limits are taken from ISO 10931-2.

8.2.3 Length deviation limits

Length deviation limits

Length	Permissible deviations
Coils	+1% 0%
up to 6 m	± 10 mm

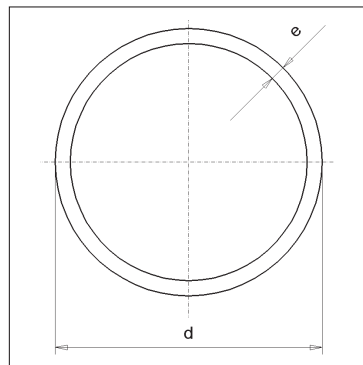

9 Basic elements of the international system of measurement (SI)

9.1	Basic Units of the international unit system (SI)	113
9.2	Units of measurement	114
9.3	Comparison of UK and US units to metric units	116

9.1 Basic units of the international unit system (SI)

In the following table we have brought together for you the internationally accepted units. Parallel to them, we have listed the units that are still acceptable, and the conversion to units that are no longer accepted. It is often helpful to scale the units up or down by decimal multiples or fractions of the units. This is done with prefixes placed before the unit name (see table). Further, we have added a comparison of the British-US units to the metric system.

Basic Units of the International Unit System (SI)

Quantity	Official unit = SI-unit	Still acceptable unit	Outdated unit Conversion
Mass			
Per unit length	kg/m		
Per unit area	kg/m ²		
Per unit volume	kg/m ³	1 g/cm ³ = 10 ³ kg/m ³	
Time			
Velocity	m/s	1 km/h = $\frac{1}{3.6}$ m/s	
Volume flow rate	m ³ /s	1 m ³ /s = 3600 m ³ /h	
Mass flow rate	kg/s	1 kg/s = 3.6 t/h	
Force, Energy, Power			
Force	N	1 N = 1 kg m/s ²	1 kp = 9.8 N ≈ 10 N
Pressure	N/m ²	1 N/mm ² = 10 ⁶ N/m ²	1 kp/cm ² ~ 0.1 N/mm ²
		1 Pa = 1 N/m ²	
		1 bar = 10 ⁵ N/m ²	1 bar = 1.02 at
		= 0.1 N/mm ²	= 0.987 atm
		= 10 ⁵ Pa	= 750 Torr
		= 10 ³ mbar	= 1.02 kp/cm ²
			= 10 m WC
			1 mbar = 10 mm WC
Tension	N/m ²	1 N/mm ² = 1 MPa	
		= 10 ⁶ N/m ²	
Energy, work	J	1 J = 1 Nm	1 kpcm = 10.2 J
		= 1 Ws	1 kcal = 4.184 KJ
		1 kWh = 3.6 MJ	
Power	W	1 W = 1 J/s	1 PS = 0.7353 kW
		= 1 Nm/s	1 kpm/s = 9.8 W
		= 1 VA	1 cal/s = 4.184 W
Impact energy	Nm		1 kpcm ~ 0.1 Nm
			~ 100 Nmm
Impact resistance	J/m ²	1 kJ/m ² = $\frac{\text{Nmm}}{\text{mm}^2}$	1 kpcm/cm ² ~ 1 kJ/m ²
Heat			
Temperature	K	1 K = °C - 273.15	
Coefficient of expansion	1/K	1/K = 1/°C	$1 \frac{\text{kcal}}{\text{m} \cdot \text{h} \cdot \text{°C}} = 1.163 \frac{\text{W}}{\text{K} \cdot \text{m}}$
			$1 \frac{\text{kcal}}{\text{m} \cdot \text{h} \cdot \text{°C}} = 1.163 \frac{\text{W}}{\text{K} \cdot \text{m}}$
Heat conductivity	$\frac{\text{W}}{\text{K} \cdot \text{m}}$		
Heat transmission	$\frac{\text{W}}{\text{K} \cdot \text{m}^2}$		
Radiation			
			1 rd = 0.01 J/kg
Dose of radiation	J/kg		1 Mrad = 10 ⁶ rd = 10 ⁴ J/kg

9.2 Units of measurement

Name of decimal multiples and fractions of a unit

Multiple UK (US)	Power of 10	Prefix	Symbol	Decimal fraction UK/US	Power of 10	Prefix	Symbol
10	10^1	deca-	da	1 : 10	10^{-1}	deci-	d
100	10^2	hecto-	h	1 : 100	10^{-2}	centi-	c
1000	10^3	kilo-	k	1 : 1000 = 0.001	10^{-3}	milli-	m
1 Million	10^6	mega-	M	1 : 1 million	10^{-6}	micro-	μ
1 Milliarde	10^9	giga-	G	1 : 1 milliard (1 : 1 billion)	10^{-9}	nano-	n
1 Billion	10^{12}	tera-	T	1 : 1 billion (1 : 1 trillion)	10^{-12}	pico	p
1 Billiarde	10^{15}	peta-	P	1 : 1 milliard (1 : 1 quadrillion)	10^{-15}	femto-	f
1 Trillion	10^{18}	exa-	E	1 : 1 trillion (1 : 1 quintilion)	10^{-18}	atto-	a

Length units

	m	μm	mm	cm	dm	km
1 m	1	10^6	10^3	10^2	10	10^{-3}
1 μm	10^{-6}	1	10^{-3}	10^{-4}	10^{-5}	10^{-9}
1 mm	10^{-3}	10^3	1	10^{-1}	10^{-2}	10^{-6}
1 cm	10^{-2}	10^4	10	1	10^{-1}	10^{-5}
1 dm	10^{-1}	10^5	10^2	10	1	10^{-4}
1 km	10^3	10^9	10^6	10^5	10^4	1

Length units

	mm	μm	nm	[Å]	pm	[mÅ]
1 mm	1	10^3	10^6	10^7	10^9	10^{10}
1 μm	10^{-3}	1	10^3	10^4	10^6	10^7
1 nm	10^{-6}	10^{-3}	1	10	10^3	10^4
1 Å]	10^{-7}	10^{-4}	10^{-1}	1	10^2	10^3
1 pm	10^{-9}	10^{-6}	10^{-3}	10^{-2}	1	10
[1 mÅ]	10^{-10}	10^{-7}	10^{-4}	10^{-3}	10^{-1}	1

Å = Ångström; 1 mÅ = 1 XU = 1 X-unit

Area units

	m ²	μm^2	mm ²	cm ²	dm ²	km ²
1 m ²	1	10^{12}	10^6	10^4	10^2	10^{-6}
1 μm^2	10^{-12}	1	10^{-6}	10^{-8}	10^{-10}	10^{-18}
1 mm ²	10^{-6}	10^6	1	10^{-2}	10^{-4}	10^{-12}
1 cm ²	10^{-4}	10^8	10^2	1	10^{-2}	10^{-10}
1 dm ²	10^{-2}	10^{10}	10^4	10^2	1	10^{-8}
1 km ²	10^6	10^{18}	10^{12}	10^{10}	10^8	1

Volume units

	m³	mm³	cm³	dm³ ①	km³
1 m ³	1	10 ⁹	10 ⁶	10 ³	10 ³
1 mm ³	10 ⁻⁹	1	10 ⁻³	10 ⁻⁶	10 ⁻⁶
1 cm ³	10 ⁻⁶	10 ³	1	10 ⁻³	10 ⁻³
1 dm ³	10 ⁻³	10 ⁶	10 ³	1	10 ⁻¹²
1 km ³	10 ⁹	10 ¹⁸	10 ¹⁵	10 ¹²	1

① 1 dm³ = 1 l = 1 Liter**Mass units**

	kg	mg	g	dt	t = Mg
1 kg	1	10 ⁶	10 ³	10 ⁻²	10 ⁻³
1 mg	10 ⁻⁶	1	10 ⁻³	10 ⁻⁸	10 ⁻⁹
1 g	10 ⁻³	10 ³	1	10 ⁻⁵	10 ⁻⁶
1 dt	10 ²	10 ⁸	10 ⁵	1	10 ⁻¹
1 t = 1 Mg	10 ³	10 ⁹	10 ⁶	10	1

Force (weight) units

	N ①	kN	MN	[kp]	[dyn]
1 N	1	10 ⁻³	10 ⁻⁶	0.102	10
1 kN	10 ³	1	10 ⁻³	0.102 · 10 ³	10 ⁸
1 MN	10 ⁶	10 ³	1	0.102 · 10 ⁶	10 ¹¹

① 1 N = 1 kg m/s² = 1 Newton**Pressure units**

	Pa	N/mm²	bar	[kp/cm²]	[Torr]
1 Pa = 1 N/m ²	1	10 ⁻⁶	10 ⁻⁵	1.02 · 10	0.0075
1 N/mm ²	10 ⁶	1	10	10.2	7.5 · 10 ³
1 bar	10 ⁵	0.1	1	1.02	750
[1 kp/cm ² = 1 at]	98,100	9.81 · 10 ⁻²	0.981	1	736
[1 Torr] ¹⁾	133	0.133 · 10 ⁻³	1.33 · 10 ⁻³	1.36 · 10	1

Temperature units (conversion between Kelvin, Rankine, Celsius and Fahrenheit)

$$T = \left(\frac{t}{^{\circ}\text{C}} + 273.15 \right) \text{K} = \frac{5}{9} \cdot \frac{T_{\text{Rank}}}{\text{Rank}} \text{K}$$

T = temperature in Kelvin

$$T_{\text{R}} = \left(\frac{t_{\text{F}}}{^{\circ}\text{F}} + 459.67 \right) \text{Rank} = \frac{9}{5} \cdot \frac{T}{\text{K}} \text{Rank}$$

T_R = temperature in Rankine

$$t = \frac{5}{9} \left(\frac{t_{\text{F}}}{^{\circ}\text{F}} - 32 \right) ^{\circ}\text{C} = \left(\frac{T}{\text{K}} - 273.15 \right) ^{\circ}\text{C}$$

t = temperature in Celsius

$$t_{\text{F}} = \left(\frac{9}{5} \cdot \frac{t}{^{\circ}\text{C}} + 32 \right) ^{\circ}\text{F} = \left(\frac{T_{\text{Rank}}}{\text{Rank}} - 459.67 \right) ^{\circ}\text{F}$$

t_F = temperature in Fahrenheit

9.3 Comparison of UK and US units to metric units

Length units

	in	ft	yd	mm	m	km
1 in	1	0.08333	0.02778	25.4	0.0254	–
1 ft	12	1	0.3333	304.8	0.3048	–
1 yd	36	3	1	914.4	0.9144	–
1 mm	0.03937	$3.281 \cdot 10^{-6}$	$1.094 \cdot 10^{-6}$	1	0.001	10^{-6}
1 m	39.37	3.281	1.094	1.000	1	0.001
1 km	39.370	3.281	1.094	10^6	1.000	1

Area units

	sq in	sq ft	sq yd	cm ²	dm ²	m ²
1 sq in	1	$6.944 \cdot 10^{-3}$	$0.772 \cdot 10^{-3}$	6.452	0.06452	$64.5 \cdot 10^{-5}$
1 sq ft	144	1	0.1111	929	9.29	0.0929
1 sq yd	1.296	9	1	8.361	83.61	0.8361
1 cm ²	0.155	$1.076 \cdot 10^{-3}$	$1.197 \cdot 10^{-4}$	1	0.01	0.0001
1 dm ²	15.5	0.1076	0.01196	100	1	0.01
1 m ²	1.550	10.76	1.196	10.000	100	1

Volume units

	cu in	cu ft	cu yd	cm ³	dm ³	m ³
1 cu in	1	$5.786 \cdot 10^{-4}$	$2.144 \cdot 10^{-5}$	16.39	0.01639	$1.64 \cdot 10^{-5}$
1 cu ft	1.728	1	0.037	28.316	28.32	0.0283
1 cu yd	46.656	27	1	764.555	764.55	0.7646
1 cm ³	0.06102	$3.532 \cdot 10^{-8}$	$1.31 \cdot 10^{-6}$	1	0.001	10^{-6}
1 dm ³	61.02	0.03532	0.00131	1,000	1	0.001
1 m ³	61.023	35.32	1.307	10^6	1.000	1

Mass units

	dram	oz	lb	g	kg	Mg
1 dram	1	0.0625	0.003906	1.772	0.00177	$1.77 \cdot 10^{-6}$
1 oz	16	1	0.0625	28.35	0.02832	$28.3 \cdot 10^{-6}$
1 lb	256	16	1	453.6	0.4531	$4.53 \cdot 10^{-4}$
1 g	0.5643	0.03527	0.002205	1	0.001	10^{-6}
1 kg	564.3	35.27	2.205	1.000	1	0.001
1 Mg	$564.4 \cdot 10^3$	35.270	2.205	10^6	1.000	1

Miscellaneous units

1 mil = 10^{-3} in	= 0.0254 mm
1 sq mil = 10^{-6} sq in	= 645.2 μm^2
1 English mile	= 1609 m
1 international sea mile	= 1852 m
1 geographical mile	= 7420 m
1 rod. pole. or perch = 5.5 yd	= 5.092 m
1 sq chain = 16 sq rods	= 404.7 m^2
1 Imp. gallon (Imperial gallon)	= 4.546 dm^3
1 US. gallon (United States gallon)	= 3.785 dm^3
1 stone (UK) = 14 lb	= 6.35 kg
1 short quarter (US)	= 11.34 kg
1 long quarter (UK. US)	= 12.70 kg
1 short cwt (US) = 4 short quarter	= 45.36 kg
1 long cwt (UK. US) = 4 long quarter	= 50.80 kg
1 short ton (US)	= 0.9072 Mg
1 Btu/cu ft	= 9.547 kcal/m^3 = 39.964 N m/m^3
1 Btu/lb	= 0.556 kcal/kg = 2.327 N m/kg
1 lb/sq ft	= 4.882 kp/m^2 = 47.8924 N/m^2
1 lb/sq in (= 1 psi)	= 0.0703 kp/cm^2 = 0.6896 N/cm^2

10 Explanations

[1]	Determining a permissible elastic or creep modulus	119
[2]	Calculating permissible stress	119
[3]	Internal overpressure example	120
[4]	Internal negative pressure or external overpressure example	121
[5]	Controlling the permissible operating overpressure p_{op} for a L expansion bend made of PE 80	124
[6]	How to determine the force on the main anchors in an axially constrained plastic pipeline	125
[7]	Effect of internal pressure testing	126
[8]	How to determine the permissible mounting distance for a thermoplastic pipeline by using SIMONA Diagrams	128

10 Explanations

[1] Determining a permissible elastic or creep modulus

This example shows how to use the equation.

Given: PP-H pipeline

Operating temperature: $T_{op} = 50\text{ °C}$

Nominal lifetime: $LT = 25\text{ years}$

Transported substance: wastewater,
no substances hazardous to water

Reduction factor for substance: $A_2 = 1.0$

(e.g. from SIMONA® SIMCHEM)

Safety factor: $SF = 1.1$

These numbers suffice to determine the permissible creep modulus for the lifetime given. The steps are:

From the SIMONA diagram in sec. 3.2, the nominal creep modulus for 25 years and operating temperature $T_{op} = 50\text{ °C}$ is $E_c = 210\text{ N/mm}^2$. From this, the permissible creep modulus (long-time elastic modulus) for further dimensioning is calculated to be:

$$\text{per } E_{c(LT)} = \frac{210}{1.0 \cdot 1.1} = 191\text{ N/mm}^2$$

This creep modulus is relevant exclusively for **deformations over long times**, e.g. pipeline sagging between support points.

[2] Calculating permissible stress

This example shows how to use the equations.

Given: PP-H pipeline

Joint method: butt welding

Operating temperature: $T_{op} = 20\text{ °C to }50\text{ °C}$

Transported substance: wastewater,
no substances hazardous to water

Reduction factor for substance: $A_2 = 1.0$

(DVS 2205-1, Table 10.4)

Material strength coefficient: $A_4 = 1.0$

(DVS 2205-1, Table 2)

Long-range joint factor: $f_s = 0.8$

(DVS 2205-1, Table 3)

Safety factor: $SF = 1.6$ ①

(DIN 8077, Table 2 respectively DVS 2205-1, Table 4)

① Since the pipeline is subject to thermal changes, and since it carries no substances hazardous to water, the safety factor 1.6 is chosen. For a constant operating temperature of 50 °C, DIN 8077 permits $SF = 1.4$.

These numbers suffice to determine the permissible hoop and longitudinal stress. The steps are:

From the SIMONA diagram in sec 2.3, for 25 years and operating temperature $T_{op} = 50\text{ °C}$ the equivalent stress is $\sigma_v = 6.10\text{ N/mm}^2$. From this, the permissible hoop stress is calculated to be:

$$\sigma_{\text{per (h)}} = \frac{6.10}{1.0 \cdot 1.0 \cdot 1.6} = 3.81\text{ N/mm}^2$$

The permissible longitudinal stress is less by the joint factor, so:

$$\sigma_{\text{per (h)}} = \frac{6.10 \cdot 0.8}{1.0 \cdot 1.0 \cdot 1.6} = 3.05\text{ N/mm}^2$$

EXPLANATIONS

With these two stress values, all stability calculations can be done for the pipeline in the example. In case that another pipeline with the same specification is to be operated, but at a different temperature, then the permissible stresses for that temperature would have to be calculated. The application of the stresses for dimensioning under internal overpressure will be treated in sec. 4.2.3.

Data about permissible internal pressure load as a function of temperature and load time are in DIN 8074 for PE-HD pipes, and in DIN 8077 for PP pipe. The SIMONA diagrams in sec. 4.2.3, which display the behaviour of the permissible internal pressure as a function of operating temperature for a customary load period of 25 years, serve as a supplement to these sources.

[3] Internal overpressure example

This example shows how to use the SIMONA diagrams for overpressure loads in thermoplastic pipelines.

Given: PP-H pipeline

Pipe dimensions: $d_e = 280$ mm, $e = 16.6$ mm

Min. operating temperature: min. $T_{op} = 20$ °C

Max. operating temperature: max. $T_{op} = 50$ °C

Operating overpressure: $p_o = 4$ bar

Transported substance: wastewater,
no substances hazardous to water; $A_2 = 1.0$

Safety factor: For a pipeline under thermal stress transporting wastewater with no substances hazardous to water, the safety factor 1.25 is assumed.

To do: Determine whether the pipeline can be operated safely under these conditions.

Pipe material: For its higher strength at higher operating temperatures, PP-H is selected. The SIMONA Diagram for PP-H contains curves for safety factors 1.6, 1.4, and 1.25. The basic pipe standard DIN 8078 differentiates between safety factors. The differentiation takes into account of the reduced strength of PP-H at temperatures < 40 °C as compared to PP-R.

Permissible internal stress falls into three cases: $T_{op} = 10$ °C– 40 °C, $T_{op} = > 40$ °C– 60 °C, and $T_{op} = 60$ °C– 80 °C. In the present case, $SF = 1.4$. The assumption of $SF = 1.25$ must be corrected.

SDR class: The SIMONA Diagram must be used in dependence on SDR class, namely the diameter to pipe wall thickness ratio. The thicker the pipe wall, the smaller the SDR class, and vice-versa. The present case the pipe has $SDR = 17$ whereas the allowable overpressure load extends to pipes with $SDR 17.6$.

Nominal pressure: The pipe with $SDR 17$ would be rated about PN 6, in the old nominal pressure rating system, now being replaced by the SDR system. Since nominal pressure ratings are familiar, they will be mentioned when helpful.

a) Graphical determination of the permissible overpressure:

From the SIMONA Diagram, it is seen that the pipe with $SDR 17$, operating temperature 50 °C, and lifetime 25 years has an permissible operating overpressure of 5.2 bar.

Result: The mentioned operating conditions at $p_o = 4$ bar are herewith fulfilled.

b) Calculation of permissible internal overpressure

Dimensioning for a pipe under internal overpressure obeys the general relation:

$$e = \frac{p_o \cdot d_e}{20 \cdot \sigma_{per} + p_o}$$

Rearranging for p_o ,

$$\text{per } p_o = \frac{20 \cdot \sigma_{per} \cdot e}{d_e - e}$$

where:

p_o	= operating overpressure	[bar]
σ_{per}	= permissible longitudinal stress	[N/mm ²]
e	= wall thickness of the pipe	[mm]
d_e	= outer diameter of the pipe	[mm]

The permissible hoop stress is calculated as in sec. 4.2.2:

$$\sigma_{per (h)} = \frac{6.10}{1.0 \cdot 1.0 \cdot 1.4} = 4.36 \text{ N/mm}^2$$

Using this permissible hoop stress, there results:

$$\text{per } p_o = \frac{20 \cdot 4.36 \cdot 16.6}{280 - 16.6} = 5.16 \text{ bar}$$

The calculated result confirms the result taken from the SIMONA diagram.

Note: These considerations apply solely to loads from internal overpressure. The stresses from tension, pressure, and bending can be superimposed on elongations from internal overpressure. This situation is always to be considered when performing a pipeline verification calculation that cannot be replaced by using the SIMONA Diagrams.

For the method for a stress verification calculation, refer to sec. 4.2.3.

[4] Internal negative pressure or external overpressure example

Given: PP-H pipeline

Pipe dimensions: $d_e = 280 \text{ mm}$, $e = 16.6 \text{ mm}$

Max. operating temperature: max. $T_{op} = 50 \text{ }^\circ\text{C}$
(from DVS 2205-1, Table 2, $A_4 = 1.0$)

Min. operating temperature: min. $T_{op} = 20 \text{ }^\circ\text{C}$

Poss. negative pressure: $p_n = 0.5 \text{ bar}$

Transported material: wastewater, $A_2 = 1.0$

Support distance: $L_A = 2500 \text{ mm}$

Pipe material: PP-H is chosen for its higher elastic modulus at higher temperatures. Especially for negative pressure loads, note that the permissible negative pressure can be larger, the higher the short-time elastic modulus of the material.

SDR class: The SIMONA diagrams are to be used with SDR ratios. The SDR ratio depends on the ratio of the pipe diameter to the wall thickness. The thicker the pipe wall, the smaller the SDR ratio for constant pipe diameter, and vice-versa. The present case the pipe has $\text{SDR} = 17$, whereas the allowable overpressure load extends to pipes with $\text{SDR} 17.6$.

EXPLANATIONS

Negative pressure load of an axially constrained

pipe run: To assure that buckling does not occur on an axially constrained pipe run, the SIMONA Diagram (see pages 44ff) indicates that the negative internal pressure must be limited to $p_{rate} \leq 585 \text{ mbar} = 0.585 \text{ bar}$.

Note: PP-H pipe with SDR 11 or 7.4 are safe from buckling at the pipe wall temperatures used in the SIMONA Diagrams. This means they are safe to operate at a negative pressure of 1.0 bar (= vacuum). There is no need for a curve for these cases.

Effect of compressive stress: For the case where a pipe run with fixed ends is subject to stress from prevention of heat expansion, please refer to sec. 4.2.4.

Examination of the axial stability: When thin-walled pipes are prevented from expanding along their axis, excessive stress can cause instability. The critical longitudinal stress for collapse by buckling can be determined as follows:

$$\sigma_{crit} = \alpha_t \cdot 0.62 \cdot E_{ST} \cdot \frac{e}{r_m}$$

where:

σ_{crit}	= critical buckling pressure in longitudinal direction	[N/mm ²]
α_t	= time-dependent calculation coefficient	[-]
E_{ST}	= short-time elastic modulus	[N/mm ²]
e	= pipe wall thickness	[mm]
r_m	= average pipe cross-section radius	[mm]

With $\alpha_t = 0.33$ for nominal lifetime of 25 years, the critical buckling stress simplifies to

$$\sigma_{crit} = 0.205 \cdot E_{ST} \cdot \frac{e}{r_m}$$

Calculation of buckling safety: To determine: whether the pipeline fulfills the interaction condition under the axial and radial pressure conditions given. All necessary equations are taken from the sections just indicated. Compression stresses are marked with a negative sign (-).

The interaction condition to be satisfied is:

$$\eta = \left(\frac{\text{act } \sigma_{\delta}}{\text{per } \sigma_{\delta}} \right)^{1.25} + \left(\frac{\text{act } p_{n,e}}{\text{per } p_{n,e}} \right)^{1.25} \leq 1.0$$

where :

act σ_{δ}	= sum of actual compression stresses in longitudinal (axial) direction
per σ_{δ}	= permissible compression stress in longitudinal direction
act $p_{n,e}$	= maximum actual internal negative pressure (or external overpressure)
per $p_{n,e}$	= permissible radial pressure

For this example, parameters are:

Diagram sec. 2.3

Short-time strength (50 °C) $\sigma_{v(10h)}^{\text{①}} = 12 \text{ N/mm}^2$

Diagram sec. 3.2

Short-time elastic modulus (50 °C) $E_{ST} = 620 \text{ N/mm}^2$

① Load time of 10 hours assumed for the maximum compression stress. Then a relaxation to about 60 % of maximum is assumed.

Permissible compression stress according to sec.

4.2.2:

$$\text{per } \sigma_{\delta} = \frac{\sigma_v}{A_2 \cdot A_4 \cdot SF}$$

$$\text{per } \sigma_{\delta} = \frac{12.0}{1.0 \cdot 1.0 \cdot 1.4} = 8.57 \text{ N/mm}^2$$

Short-time compression stress from suppressed thermal expansion, from sec. 4.2.4:

$$\sigma_{i(dT)} = -\alpha \cdot \Delta T \cdot E_{(ST)}$$

$$\sigma_{i(dT)} = -0.00016 \cdot 30 \cdot 620 = -2.98 \text{ N/mm}^2$$

Short-time compression stress from internal negative pressure, from sec. 4.2.4:

$$\sigma_{i(pn,pe)} = - \frac{p_n}{10} \cdot \frac{(d_e/d_i)^2}{(d_e/d_i)^2 - 1}$$

$$\sigma_{i(pn,pe)} = - \frac{0.5}{10} \cdot \frac{(280/248.2)^2}{(280/248.2)^2 - 1} = -0.23 \text{ N/mm}^2$$

Long-time bending compression stress from pipe sag, from sec. 4.2.4:

$$\sigma_{i(b)} = - \frac{q \cdot L_A^2}{8 \cdot W_R}$$

$$\sigma_{i(b)} = - \frac{0.615 \cdot 2500^2}{8 \cdot 8.7 \cdot 10^5} = -0.56 \text{ N/mm}^2$$

Critical buckling pressure of the pipe run at 50°C
(radial direction):

$$p_{crit} = \frac{2 \cdot 620}{1 - 0.38^2} \cdot \frac{16.6^3}{280^3} = 0.302 \text{ N/mm}^2 \cdot 10 = 3.02 \text{ bar}$$

Permissible radial load: The permissible load from negative internal pressure or external overpressure, requiring a buckling safety of $S_{buck} = 2.0$, is given by:

$$\text{per } p_{n,e} = p_{crit}/S_{buck} = 3.02/2.0 = 1.51 \text{ bar}^{\text{②}}$$

② The permissible negative pressure from the SIMONA Diagram is $p_n = 0.585$ bar; this takes into account the axial restraint and also deviations from imperfection, which can occur as pipes bend. The pipe sagging generates bending compression stress, superimposed on the other compression stresses. Therefore the diagrams can only give limiting values for a detrimental case, which has to be optimized by calculations.

Load in axial direction: the actual longitudinal compression stress load for negative pressure is:

$$\text{act } \sigma_{\delta} = \sigma_{dT} + \sigma_{pn} + \sigma_b$$

$$\text{act } \sigma_{\delta} = (-2.98) + (-0.23) + (-0.56) = -3.77 \text{ N/mm}^2$$

Critical buckling stress in axial direction:

$$\begin{aligned} \sigma_{crit(a)} &= 0.205 \cdot 620 \cdot 16.6 / [0.5 \cdot (280 - 16.6)] \\ &= 16.02 \text{ N/mm}^2 \end{aligned}$$

It is obvious that the critical buckling stress for thick-walled pipes is definitely higher than the permissible compression stress. Therefore, for axially constrained pipe runs it is advisable to calculate the interaction (act σ_{δ} /per σ_{δ}).

The interaction condition to be satisfied:

$$\eta = \left(\frac{3.77}{8.57} \right)^{1.25} + \left(\frac{0.5}{1.06} \right)^{1.25} = 0.75$$

Result of the investigation: It confirms a sufficient margin of safety to prevent buckling.

EXPLANATIONS

[5] Controlling the permissible operating overpressure p_{op} for a L expansion bend made of PE 80

Given:

Pipe diameter: $d_e = 280$ mm

Operating pressure: $P_{op} = 5.0$ bar

Minimum operating temperature: $\min T_{op} = 20$ °C

Maximum operating temperature: $\max T_{op} = 40$ °C

Reduction through transported substance: $A_2 = 1.0$

Safety factor: SF 1.25

LT welding factor: $f_{LT} = 0.8$

Calculated life time: 25 years

System length for L expansion bend:

sum $L_1 = 9,500$ mm

Permissible operating overpressure acc. to SIMONA diagrams in sec. 3.1:

permissible operating overpressure for expansions bends: corresponding per p_o for straight pipe runs

Required pipe wall thickness respectively permissible operating pressure of the pipe:

From the SIMONA diagram (see page 61), for PE 80 at the given operating conditions with safety factor of 1.25, the pipe must have SDR 17, i.e. wall thickness $e = 16.6$ mm. The permissible overpressure load of the pipe is read off as per $p_o = 5.6$ bar.

Result: With $p_o = 5.6$ for the straight pipe run and for the expansion bend, the operating pressure of $P_{op} = 5.0$ fulfils permissible limits.

Note: The calculation of permissible overpressure loads in Z and U expansion bends as well as other materials and operating conditions has to be done accordingly.

Calculating expansions bend dimensions

Inner diameter of the pipe :

$$d_i = 280 - 2 \cdot 16.6 = 246.8 \text{ mm}$$

out of diagram sec. 2.2:

$$E_{(\min \text{ Top})} = 235 \text{ N/mm}^2$$

$$E_{(\max \text{ Top})} = 120 \text{ N/mm}^2$$

average creep modulus :

$$E_{cm} = (0.5 \cdot (235 + 120)) / 1.0 = 177.5 \text{ N/mm}^2$$

out of diagram sec. 2.1:

$$\sigma_v \text{ for } \max T_o = 5.8 \text{ N/mm}^2$$

acc. to sec. 2.3:

$$\sigma_{all(l)} = 5.8 \cdot 0.8 / (1.0 \cdot 1.0 \cdot 1.25) = 3.71 \text{ N/mm}^2$$

acc. to sec. 3.3:

$$\sigma_{(p)} = 5.0 / 10 \cdot 1 / ((280 / 246.8)^2 - 1) = 1.74 \text{ N/mm}^2$$

acc. to sec. 3.3:

$$\text{per } \sigma_{(b)} = 3.71 - 1.74 = 1.97 \text{ N/mm}^2$$

temperature change :

$$dT = \max T_{op} - \min T_{op} = 20 \text{ K}$$

With the fore mentioned data the minimum length of the expansion bend L_{E1} will be calculated:

$$\text{req } L_{E1} = \sqrt{\frac{3 \cdot 280 \cdot 9,500 \cdot 20 \cdot 0.00018 \cdot 177.5}{1.74}} = 1712 \text{ mm}$$

For the minimum length of the expansion bend L_{E2} you have to consider:

$$\text{req } L_{E2} = \sqrt{\frac{3 \cdot 280 \cdot 1,712 \cdot 20 \cdot 0.00018 \cdot 177.5}{1.74}} = 727 \text{ mm}$$

Following the example and using the SIMONA diagram on p. 64 you get expansion bend lengths $L_{E1} = 1.730$ mm and $L_{E2} =$ approx. 720 mm. It can be stated that the graphically determined expansion bend lengths are well in line with the calculated ones.

The dimensions of the Z and U expansion bends are to be calculated in same way.

[6] How to determine the force on the main anchors in an axially constrained plastic pipeline

Given: PE 100 pipeline

Pipe measurements: $d_e = 280$ mm; $e = 16.6$ mm

Minimum operating temperature: $\min T_o = 20^\circ\text{C}$

Maximum operating temperature: $\max T_o = 40^\circ\text{C}$

Installation temperature: $\min T_i = 20^\circ\text{C}$

Transported substance: wastewater

To determine: the force on the main anchors when the pipeline is axially constrained under the given operating conditions.

Pipe material: PE 100 is selected over PE 80 for its higher strength under internal pressure. This choice has no effect on the pipeline anchor forces, since the relevant material parameter, the elasticity modulus, is similar for the two plastics.

SDR class: SIMONA Diagrams give different anchor loads for different SDR ratios. Wall thickness influences anchor forces; the thicker the pipe wall, the higher the anchor point load. Therefore the pipe length has no bearing on it.

Pipe wall temperature: So that the load can be determined at its maximum, take the pipe wall temperature as the maximum working temperature.

Anchor load from preventing thermal expansion: For SDR 17 pipe, $d_e \times e = 280 \times 16.6$ mm, the SIMONA Diagram on p. 83 gives $F_{FP} = 23$ kN as the maximum anchor force from prevention of thermal expansion.

This result is for a temperature difference of 20 K. The temperature difference is between installation and maximum operating temperatures: $\Delta T = \max T_o - \min T_i$. If the minimum operating temperature is less than the installation temperature, then ΔT is given by $\Delta T = \max T_o - \min T_o$. If the pipeline can be taken out of operation, then the pipe wall temperature can sink to the ambient temperature. For pipelines outdoors, this can lead to extreme temperature differences, which must then be used to determine the anchor force.

To calculate the anchor force from prevented thermal expansion, the procedure is:

$$F_{FP} = \alpha \cdot \Delta T \cdot A_{\text{pipe}} \cdot E_{\text{cm}(100\text{min})}$$

where:

α	= coefficient of linear expansion	[1/K]
ΔT	= temperature difference	[K]
A_{pipe}	= pipe wall surface area	[mm ²]
$E_{\text{cm}(100\text{min})}$	= average creep modulus for $t = 100$ min	[N/mm ²]

SIMONA Diagrams in sec. 3.1 give creep modulus values for PE. Average values for α are found in the table of sec. 5.3.2.

EXPLANATIONS

Using these values:

$$E_{cm(100min)} = 0.5 \cdot (E_{c20^{\circ}C} + E_{c40^{\circ}C}) = 0.5 \cdot (595 + 325) \\ = 460 \text{ N/mm}^2$$

$$F_{FP} = 1.8 \cdot 10^4 \cdot 20 \cdot 13736 \cdot 460 = 22.8 \text{ kN}$$

This calculated result is in good agreement with the value read off the SIMONA Diagram.

Note: The anchor forces found in the SIMONA Diagrams give loads on the support structure. The pressure or tension in the pipeline must be considered in a separate pipeline stress analysis (see sec. 4.2.4).

[7] Effect of internal pressure testing

In an internal pressure test, to prove that the pipeline will be safe in working conditions, it is subjected to increased pressure – currently 150% of the nominal pressure rating. In this case, pipe and fittings have SDR 17, corresponding to PN 6. Test pressure is then $1.5 \cdot 6 = 9$ bar. How does this affect anchor load?

Anchor load during testing: To determine the anchor load from pressure testing, assume that in the pipe run a tensile stress is generated, resulting in expansion. To the extent that is is prevented, the anchors are subject to forces that can be found as follows:

$$F_{test} = \frac{0.1 \cdot p \cdot (1 - 2\mu)}{(d_e/d_i)^2 - 1} \cdot A_{pipe}$$

where:

p	= test pressure	[bar]
μ	= transversal contraction (Poisson's ratio) = 0.38 for thermoplastics	[-]
d _e	= external pipe diameter	[mm]
d _i	= internal pipe diameter	[mm]
A _{pipe}	= pipe wall surface area	[mm ²]

Substituting the relevant values in the equation gives:

$$F_{test} = \frac{0.1 \cdot 9 \cdot (1 - 2 \cdot 0.38)}{[(280/246.8)^2 - 1] \cdot 10^3} \cdot 13736 = 10.4 \text{ kN}$$

In this case, the anchor load from internal pressure testing is less than that from prevention of thermal expansion.

Friction on pipe supports: When a pipe run expands axially, the contact with pipe supports generates friction, which opposes the expansion. Thus the length change is in reality less than the calculated value.

Anchor load from friction: For the anchor load, the friction force from a pipe run of the appropriate length is to be determined. The specific friction force, per running meter, is found from:

$$F_R = (q_p + q_c + q_A) \cdot \mu_R$$

where:

q _p	= pipeline weight (per running meter)	[N/m]
q _c	= weight of pipe contents (transported substance)	[N/m]
q _A	= added weight	[N/m]
μ _R	= coefficient of friction = 0.3 to 0.5	[-]

Additional values for the example:

Moveable pipe length = 50 m

sum q = weight of pipe and contents
(transported substance) = 615 N/m

$\mu_R = 0.3$

This gives the total friction force anchor load as:

$$F_R = (615 \text{ N/m}) \cdot 0.3 \cdot 50 \text{ m} = 9225 \text{ N} = 9.23 \text{ kN}$$

Note: Anchor load from friction on pipe supports depends on the total pipeline weight, the coefficient of friction, and the length of pipe that can expand. In this case, the load is considerably less than that from prevented thermal expansion.

Anchor load from internal pressure: When bellows-type expansion joints are used, anchor load considerations are dominated by internal pressure. The effect of internal pressure on the expansion joint surface must be determined; the resulting anchor force is:

$$F_p = A_j \cdot 0.1 \cdot p_o$$

where:

p_o = internal overpressure [bar]
 A_j = the pressurized bellows joint surface area [mm²]

Substituting:

d_k = pressurized joint diameter
= 300 mm

max $p_o = 9$ bar

gives the anchor load with bellows-type expansion joints as:

$$F_p = 300^2 \cdot \pi/4 \cdot 0.1 \cdot 9 = 63617 \text{ N} = 63.6 \text{ kN}$$

This is by far the largest anchor load.

Note: The example demonstrates how varied the anchor force calculations and the loads can be. There is also anchor force from swelling caused by solvent absorption into pipe. This special case, not treated here, must be analyzed within the framework of applicable projects, and cannot be generalized.

When dimensioning for anchors, the case of maximum load must be analysed. Sometimes various simultaneous situations are super-imposed. Then to get the maximum anchor load the individual loads must be added, with attention to direction and sign.

EXPLANATIONS

[8] How to determine the permissible mounting distance for a thermoplastic pipeline by using SIMONA Diagrams

Given: PE 100 pipeline

Pipe measurements:

$d_e = 63 \text{ mm}$; $e = 5.8 \text{ mm}$ (SDR 11)

Minimum operating temperature: $\min T_o = 20 \text{ }^\circ\text{C}$

Maximum operating temperature: $\max T_o = 40 \text{ }^\circ\text{C}$

Transported substance: wastewater with no substance hazardous to water; $A_2 = 1.0$

Transported substance density: $\rho = 1.1 \text{ g/cm}^3$

To determine: the spacing between fixings required for laying the pipe under the given operating conditions.

Pipe material: PE 100 is selected over PE 80 for its higher strength under internal pressure. This choice has no effect on sagging, since the relevant material parameter, the elasticity modulus, is similar for the two plastics.

SDR class: The SIMONA diagram for permissible fixing distance can be used independently of SDR ratios. The calculations use the sum of pipe weight and contents weight at density $\rho = 1.0 \text{ g/cm}^3$. An increase of wall thickness or higher pipe material specific weight, e.g. using PVDF, hardly affects the sagging deflection.

Influence of transported substance: What definitely must be taken into account is the specific weight of the transported material, since an increase of ρ over 1.0 g/cm^3 at the mounting distance recommended in the SIMONA Diagram will lead to increased sag. The conversion factor f_x for the throughput density dependent of the change in fixing distance may be taken from the following table.

Using the same conversion factor for all pipe plastics has little practical effect on the sagging, so no differentiation will be made.

Effect of transported substance on fixing distance:

Please refer to the following table.

Permissible fixing distance: The SIMONA diagram for PE 80/PE 100 pipe shows the fixing distance $L_A = 950 \text{ mm}$ for pipe size $d_e = 63 \text{ mm}$ and operating temperature $T_o = 40 \text{ }^\circ\text{C}$. Since the transported material density is 1.1 g/cm^3 , the permissible fixing distance is $L_A = 0.98 \cdot 950 \text{ mm} = 930 \text{ mm}$. This is a significant difference.

Note: Determination of mounting distance by the SIMONA Diagram includes all significant influences on the plastic pipeline. The bending stress $\sigma_{I(b)}$, well under 1.0 N/mm^2 , has a very minor effect in a stress analysis.

Transported substance density [g/cm^3]

Conversion factor	Gases	$\rho = 1.1$	$\rho = 1.2$	$\rho = 1.3$	$\rho = 1.4$	$\rho = 1.5$
f_x	1.3	0.98	0.96	0.94	0.92	0.90



11 Services

As a customer, you always take centre stage: from project development to materials procurement and on-site planning, we are committed to providing the very best consulting services. Our long-standing experience is your gain.

Consulting and information service



We have channelled considerable resources into technical consulting and would be delighted to share our know-how with you. We offer global consulting services, headed by highly qualified staff at our Technical Sales Support unit and within our field sales organisation – from project planning and product selection to on-site assistance tailored to your applications.

Project planning

We advise project planners and contractors on the selection of suitable materials and products as well as on the most efficient methods of installation. It would be a great pleasure for us to assist you in addressing all technical issues related to your specific project, e.g. pipe-laying installation, structural calculations or joining technology.

SUPPORT

+49 (0) 67 52 14-254
pipingsystems@simona.de



On-site consulting

We are happy to provide active support at all stages of your project. Our qualified engineers will assist you on site throughout your construction project and also advise you on technical matters subsequent to completion.

Training

We also offer a range of training courses and seminars for customer personnel – organised at your premises or at our Technology Centre in Kirn.

Reliability and flexible service

Our central warehouse and global distribution centres supply SIMONA standard products from stock, thus guaranteeing speedy and flexible delivery.

Standard tendering documents

To view standard tendering documents for our products, please refer to our SIMONA® SIMCAT CD-ROM or visit our website at www.simona.de.

Information service

Further information is available in the form of

- Brochures
- Product information leaflets
- CD-ROMs.

Our full product range for pipes, fittings and valves is listed in our Gross Price List (print version) and on the Internet at www.simona.de



INFO

+49 (0) 67 52 14-383
marketing@simona.de

Technical services



Our products are subjected to a range of thorough technical assessments as well as endurance testing. As part of this programme, our in-house laboratory conducts regular tests on material properties and long-term performance.

We are happy to pass on our knowledge, as well as performing specialist tests on your behalf.

Materials testing

- Immersion tests according to DIN 16888 Part 1–2 and ISO 4433 Part 1–4
- Evaluation of reduction factors through immersion tests or creep-depending-on-time tests under internal compression
- Probability analysis regarding stress cracks induced by liquids
- Assessment of permeation for applications in composite construction and lining technology with corresponding material recommendation

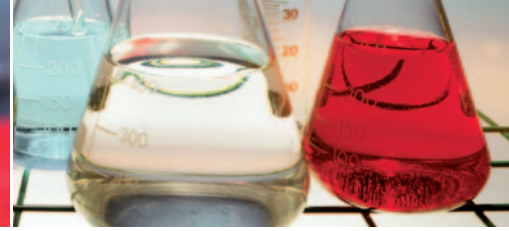

Equipment and accessories

We are able to supply you with specialist equipment and accessories required for professional welding and processing, such as welding machines for electrofusion or heated element butt welding as well as tensioning devices and other processing machinery. Specialist equipment can be either purchased or hired.

Structural analysis

We perform structural calculations in the following areas:

- Underground pipe installation
- Ventilation piping systems
- Shaft systems and
- Lining projects.

ATEX advisory service

- Selection of materials
- Details relating to standards and regulations
- Information on processing of electrically conductive products

Customised pipes and fittings

Alongside our standard product range, we offer a premium-class package of specialist solutions:

- Pipes in various lengths for a range of joining methods
- Special pipe sizes adapted to the standard nominal diameters of other materials
- Pipes with non-standard properties such as electrical conductivity or low flammability
- Customised fittings as system components for your application

SIMONA® SIMCHEM

SIMCHEM 6.0 – Chemical resistance data on CD-ROM

SIMCHEM 6.0 is a reliable and comprehensive guide when it comes to determining the chemical resistance of materials used in our products.

It lists more than 3,000 media and proprietary products. Additionally, SIMCHEM provides extensive information about our products and materials, as well as outlining SIMONA's business activities.



SIMCHEM – An extensive database on the chemical resistance of SIMONA® materials, featuring more than 3,000 listed substances.

The sixth edition of SIMCHEM has been fully reviewed and is an important guide for your day-to-day operations. Please be advised that all data presented in this version reflects our scope of knowledge at the point of publication. The latest version of SIMCHEM is based on findings from immersion testing as part of which test specimens were subjected to different temperatures in the medium in question, free from external stresses.

The data derived from testing is complemented by case study reports, recommendations by raw material manufacturers as well as extensive data relating to standards, directives and guidelines.

ORDER SIMCHEM 6.0

+49 (0) 67 52 14-383
marketing@simona.de

SIMONA worldwide

SIMONA AG

Teichweg 16 D-55606 Kirn Germany

Phone +49 (0) 67 52 14-0
Fax +49 (0) 67 52 14-211
mail@simona.de
www.simona.de

PRODUCTION SITES

Plant I/II

Teichweg 16
D-55606 Kirn
Germany
Phone +49 (0) 67 52 14-0
Fax +49 (0) 67 52 14-211

Plant III

Gewerbestraße 1-2
D-77975 Ringsheim
Germany
Phone +49 (0) 78 22 436-0
Fax +49 (0) 78 22 436-124

SIMONA Plast-Technik s.r.o.

U Autodílen 23
CZ-43603 Litvínov-Chudeřín
Czech Republic

SIMONA AMERICA Inc.

64 N. Conahan Drive
Hazleton, PA 18201
USA

SIMONA ENGINEERING PLASTICS (Guangdong) Co. Ltd.

No. 368 Jinou Road
High & New Technology Industrial
Development Zone
Jiangmen, Guangdong
China 529000

SALES OFFICES

SIMONA S.A. Paris

Z.I. 1, rue du Plant Loger
F-95335 Domont Cedex
Phone +33 (0) 1 39 35 49 49
Fax +33 (0) 1 39 91 05 58
domont@simona-fr.com

SIMONA UK LIMITED

Telford Drive
Brookmead Industrial Park
GB-Stafford ST16 3ST
Phone +44 (0) 1785 22 24 44
Fax +44 (0) 1785 22 20 80
mail@simona-uk.com

SIMONA AG SCHWEIZ

Industriezone
Bäumlimattstraße 16
CH-4313 Möhlin
Phone +41 (0) 61 8 55 90 70
Fax +41 (0) 61 8 55 90 75
mail@simona-ch.com

SIMONA S.r.l. ITALIA

Via Padana
Superiore 19/B
I-20090 Vimodrone (MI)
Phone +39 02 25 08 51
Fax +39 02 25 08 520
mail@simona-it.com

SIMONA IBERICA SEMIELABORADOS S.L.

Doctor Josep Castells, 26-30
Polígono Industrial Fonollar
E-08830 Sant Boi de Llobregat
Phone +34 93 635 41 03
Fax +34 93 630 88 90
mail@simona-es.com
www.simona-es.com

SIMONA-PLASTICS CZ, s.r.o.

Zděbradská ul. 70
CZ-25101 Říčany-Jažlovice
Phone +420 323 63 78 3-7/-8/-9
Fax +420 323 63 78 48
mail@simona-cz.com
www.simona-cz.com

SIMONA POLSKA Sp. z o.o.

ul. H. Kamieńskiego 201-219
PL-51-126 Wrocław
Phone +48 (0) 71 3 52 80 20
Fax +48 (0) 71 3 52 81 40
mail@simona-pl.com
www.simona-pl.com

SIMONA FAR EAST LIMITED

Room 501, 5/F
CCT Telecom Building
11 Wo Shing Street
Fo Tan
Hongkong
Phone +852 29 47 01 93
Fax +852 29 47 01 98
sales@simona.com.hk

SIMONA ENGINEERING PLASTICS TRADING (Shanghai) Co. Ltd.

Room C, 19/F, Block A
Jia Fa Mansion
129 Da Tian Road, Jing An District
Shanghai
China 200041
Phone +86 21 6267 0881
Fax +86 21 6267 0885
shanghai@simona.com.cn

SIMONA AMERICA Inc.

64 N. Conahan Drive
Hazleton, PA 18201
USA
Phone +1 866 501 2992
Fax +1 800 522 4857
mail@simona-america.com
www.simona-america.com

Upon publication of this document all previous editions shall become void. For relevant changes within this edition, please refer to our company website at www.simona.de. All information furnished herein reflects our scope of knowledge at the point of publication (errors and omissions excepted). The information furnished shall not constitute the provision of legally binding guarantees as to specific product-related properties or their suitability for specific areas of application. We shall assume no liability for the application, utilisation, processing or other use of this information or of our products. Furthermore, we shall assume no liability for any consequences related thereto. The purchaser is obliged to examine the quality and properties of these products; he shall be fully responsible for selecting, applying, utilising and processing said products. We provide warranty for the faultless quality of our products within the framework of our Standard Terms and Conditions of Sale.



SIMONA AG

Teichweg 16

D-55606 Kirn

Phone +49 (0) 67 52 14-0

Fax +49 (0) 67 52 14-211

mail@simona.de

www.simona.de